

**ROBOTINA d.o.o.**  
Oprema in sistemi za  
avtomatizacijo  
TEL: 066 647 203  
FAX: 066 648 218

datum	22.12.99
projektiral	Ivan Morano
pregledal	
verzija	PZI 1.0

podpis	
--------	--

VRTLJIVI ZERJAV - OD 5	
20/15/10 Mp x 25/30 m	
objekt	

LUKA	
KOPER	
investitor	

KABEL BOBEN, DOVOD, PORABNIKI PRED GLAVNIM STIKALOM	
St. projekta	Skupina
99060030	-2 -03 -0/1

NAP	=1
	+L1
	stran 1
	strani 37

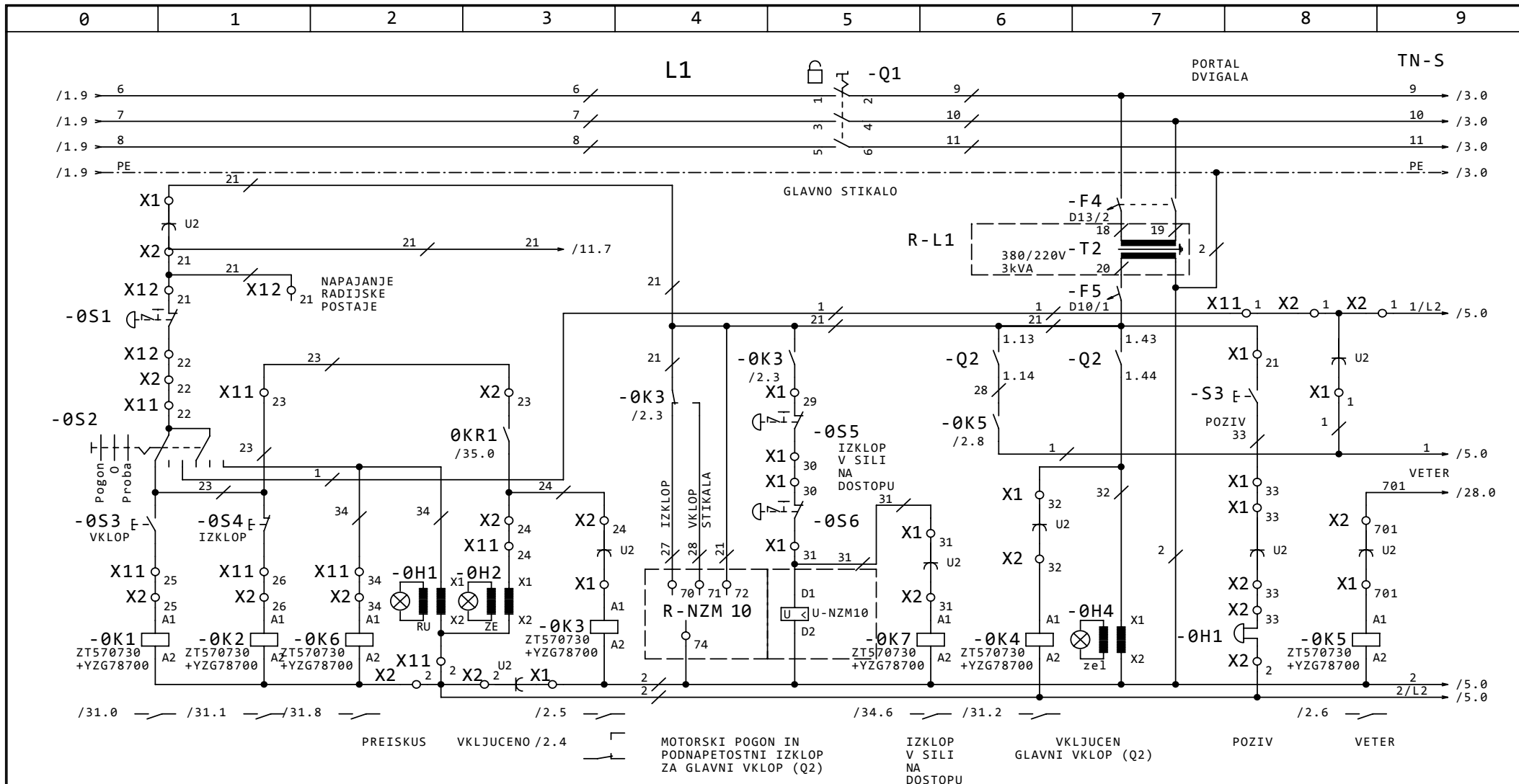

**OPOMBA:**  
 X1:...SPONKE V OMARI L1 (NA PORTALU)  
 X2:...SPONKE V OMARI L2 (VRTLJIVI DEL)  
 X21:...SPONKE V OMARI R-L2 (VRTLJIVI DEL)  
 X11:...SPONKE ZA PULT L11 (KABINA)  
 X12:...SPONKE ZA PULT L12 (KABINA)

 <b>ROBOTINA d.o.o.</b> Oprema in sistemi za avtomatizacijo TEL: 066 647 203 FAX: 066 648 218	datum	22.12.99	podpis	<b>VRTLJIVI ZERJAV - OD 5</b> <b>20/15/10 Mp x 25/30 m</b> objekt	<b>LUKA</b> <b>KOPER</b> investitor	KRMILNA NAPETOST IN KRMILJE GLAVNEGA VKLOPA St. projekta Skupina <b>99060030 -2 -03 -0/2</b>	NAP	=1
	projektiral	Ivan Morano						+L1
	pregledal							stran 2
	verzija	PZI 1.0						strani 37

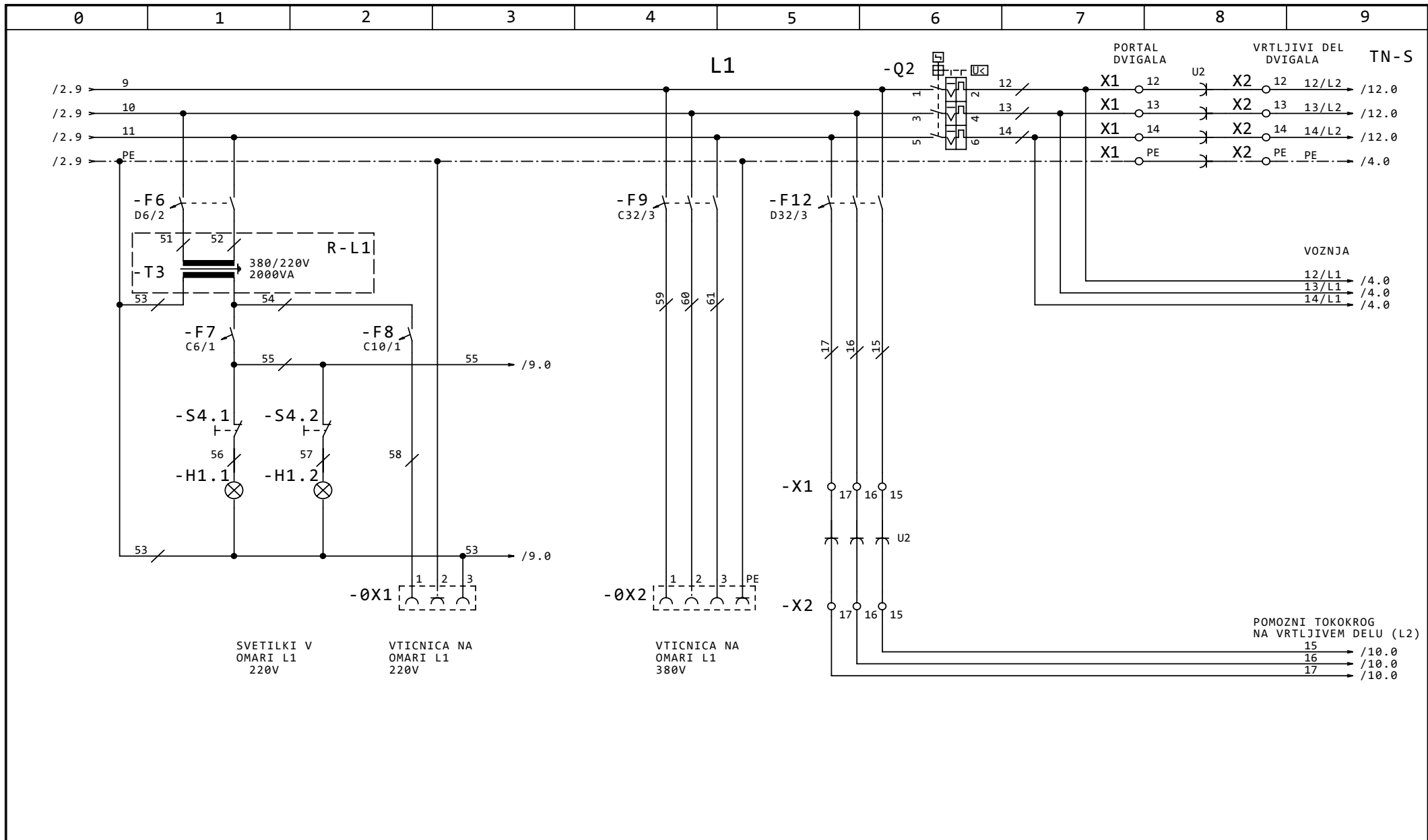

**ROBOTINA d.o.o.**  
 Oprema in sistemi za  
 avtomatizacijo  
 TEL: 066 647 203  
 FAX: 066 648 218

datum	06.01.100	podpis	
projektiral	Ivan Morano		
pregledal			
verzija	PZI 1.0		

**VRTLJIVI ZERJAV - OD 5**  
**20/15/10 Mp x 25/30 m**

objekt

**LUKA**  
**KOPER**

investitor

POMOZNI TOKOKROG  
 RAZSVETLJAVA V OMARI L1

St. projekta 99060030  
 Skupina -2 -03 -0/3

NAP	=1
	+L1
	stran 3
	strani 37

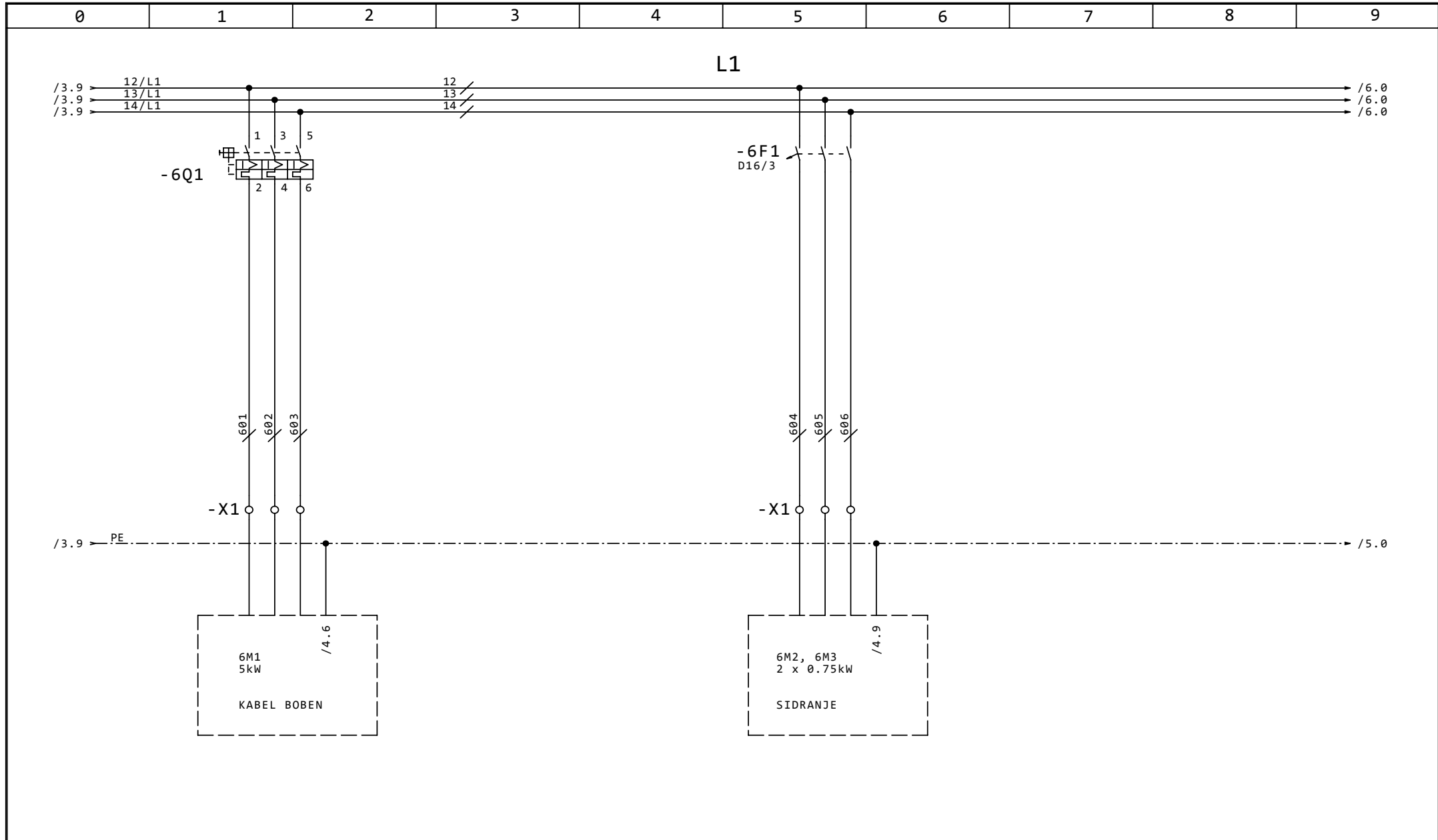

**ROBOTINA d.o.o.**  
 Oprema in sistemi za  
 avtomatizacijo  
 TEL: 066 647 203  
 FAX: 066 648 218

datum	22.12.99	podpis		VRTLJIVI ZERJAV - OD 5	LUKA	KABEL BOBEN IN SIDRANJE DVIGALA	VOZ	=1
projektiral	Ivan Morano			20/15/10 Mp x 25/30 m	KOPER	ENERGETSKI DEL V L1		+L1
pregledal				objekt	investitor	St. projekta	Skupina	stran 4
verzija	PZI 1.0					99060030	-2 -03 -6/1	strani 37



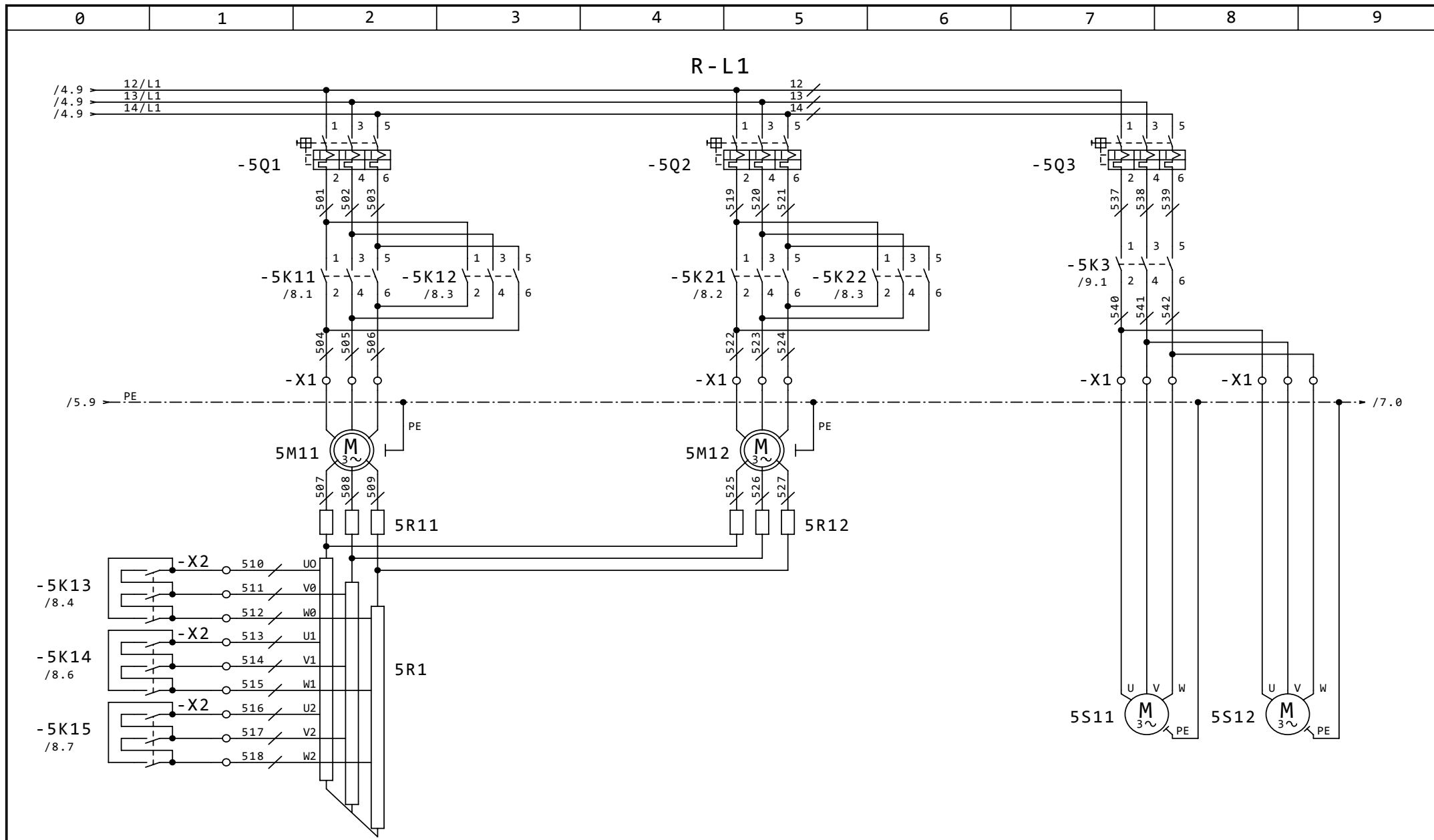

ROBOTINA d.o.o.  
 Oprema in sistemi za  
 avtomatizacijo  
 TEL: 066 647 203  
 FAX: 066 648 218

datum	22.12.99	podpis
projektiral	Ivan Morano	
pregledal		
verzija	PZI 1.0	

VRTLJIVI ZERJAV - OD 5  
 20/15/10 Mp x 25/30 m  
 objekt

LUKA  
 KOPER  
 investitor

VOZNA DVIGALA  
 ENERGETSKI DEL V L1  
 St. projekta Skupina  
 99060030 -2 -03 -5/1

VOZ	=1
	+L1
	stran 6
	strani 37

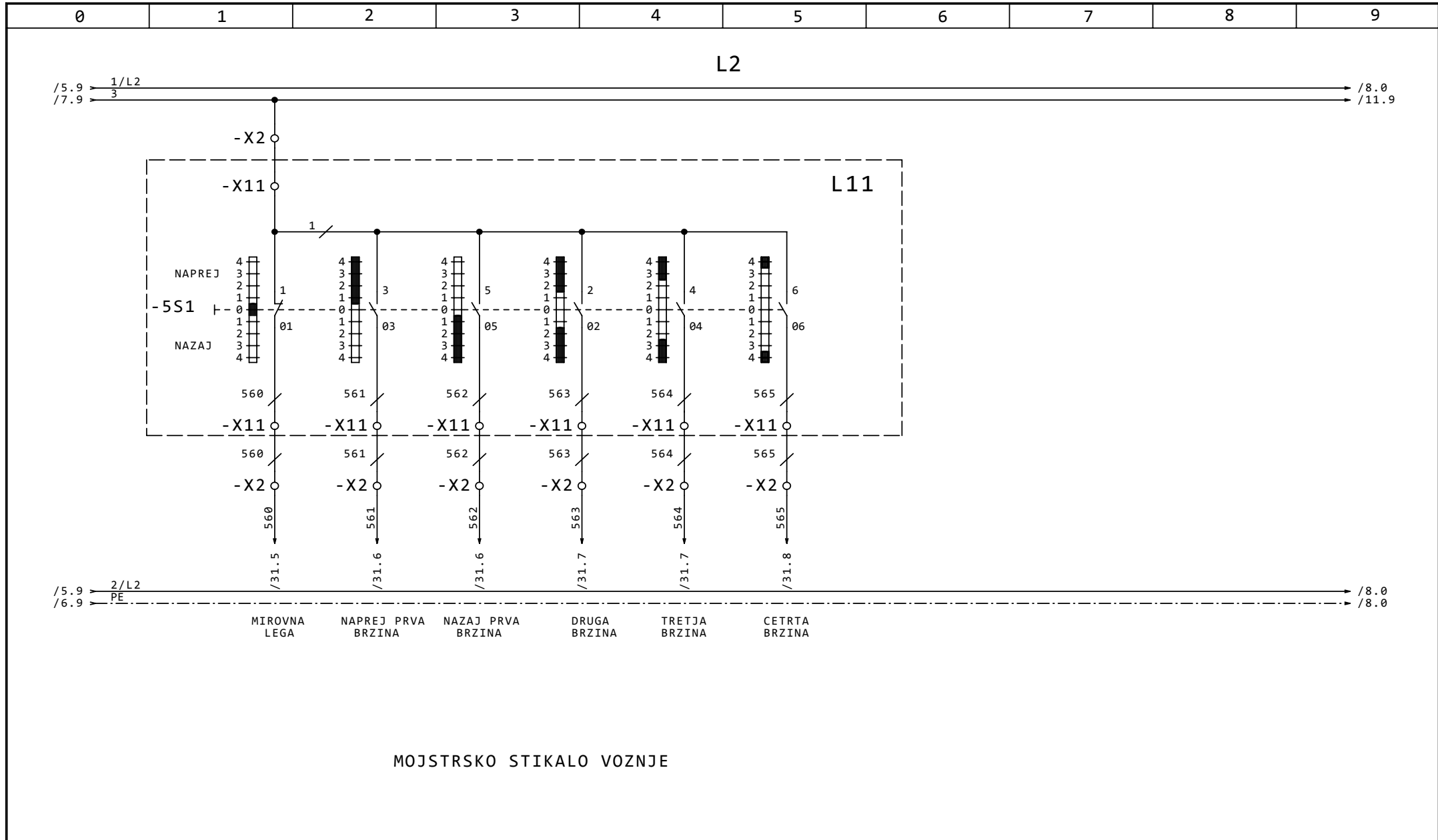

**ROBOTINA d.o.o.**  
 Oprema in sistemi za  
 avtomatizacijo  
 TEL: 066 647 203  
 FAX: 066 648 218

datum	22.12.99	podpis	VRTLJIVI ZERJAV - OD 5 20/15/10 Mp x 25/30 m	LUKA KOPER	VOZNA DVIGALA KRMILNI DEL V L2	VOZ =2 +L2	
projektiral	Ivan Morano	objekt			investitor		St. projekta Skupina
pregledal							99060030 -2 -03 -5/4
verzija	PZI 1.0					stran 7 strani 37	

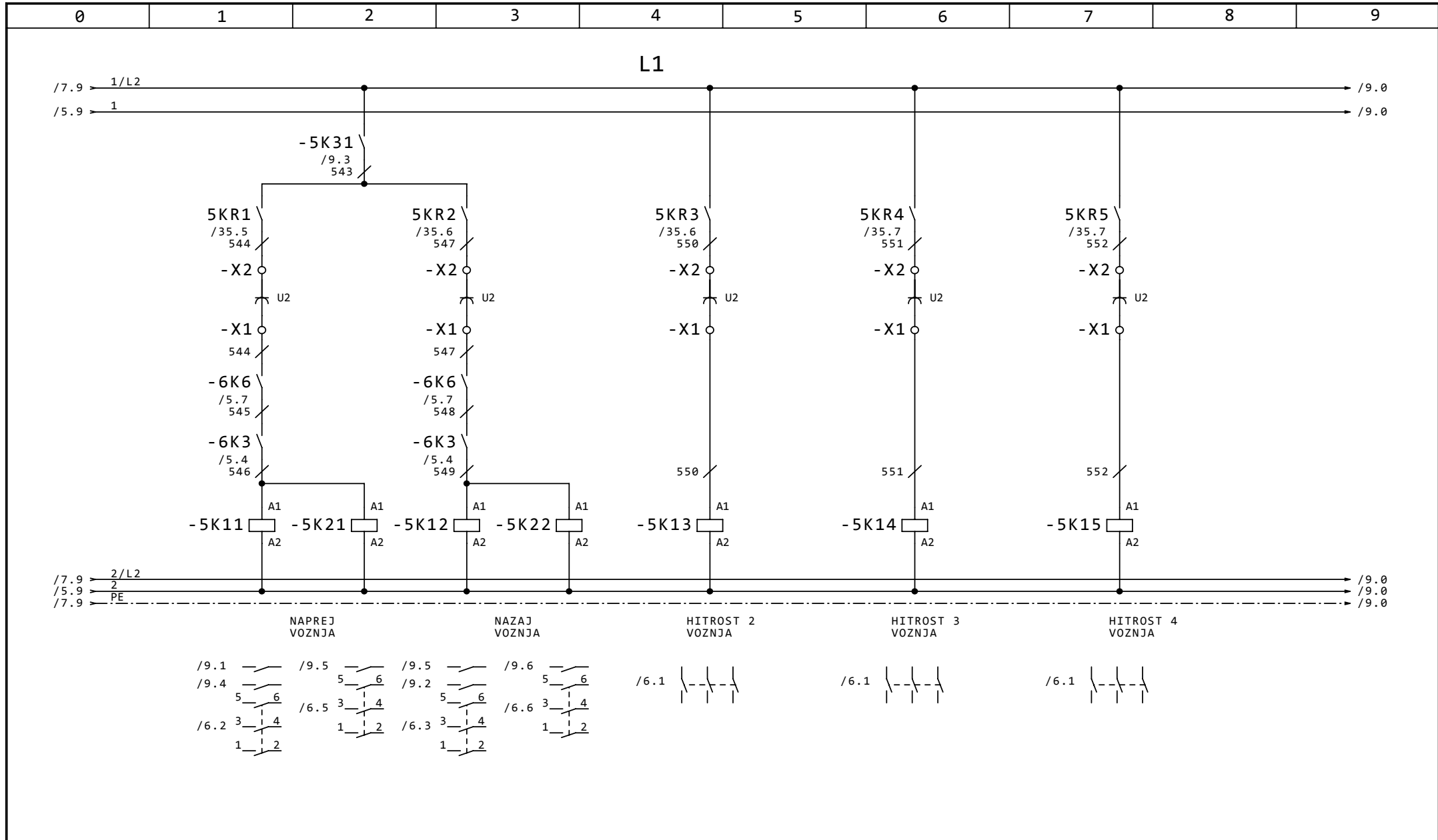

**ROBOTINA d.o.o.**  
 Oprema in sistemi za  
 avtomatizacijo  
 TEL: 066 647 203  
 FAX: 066 648 218

datum	22.12.99	podpis		VRTLJIVI ZERJAV - OD 5	LUKA	VOZNA DVIGALA	VOZ	=1
projektiral	Ivan Morano			20/15/10 Mp x 25/30 m	KOPER	KRMILNI DEL V R-L1		+R-L1
pregledal				objekt	investitor	St. projekta		stran 8
verzija	PZI 1.0					Skupina		strani 37
						99060030	-2-03-5/2	



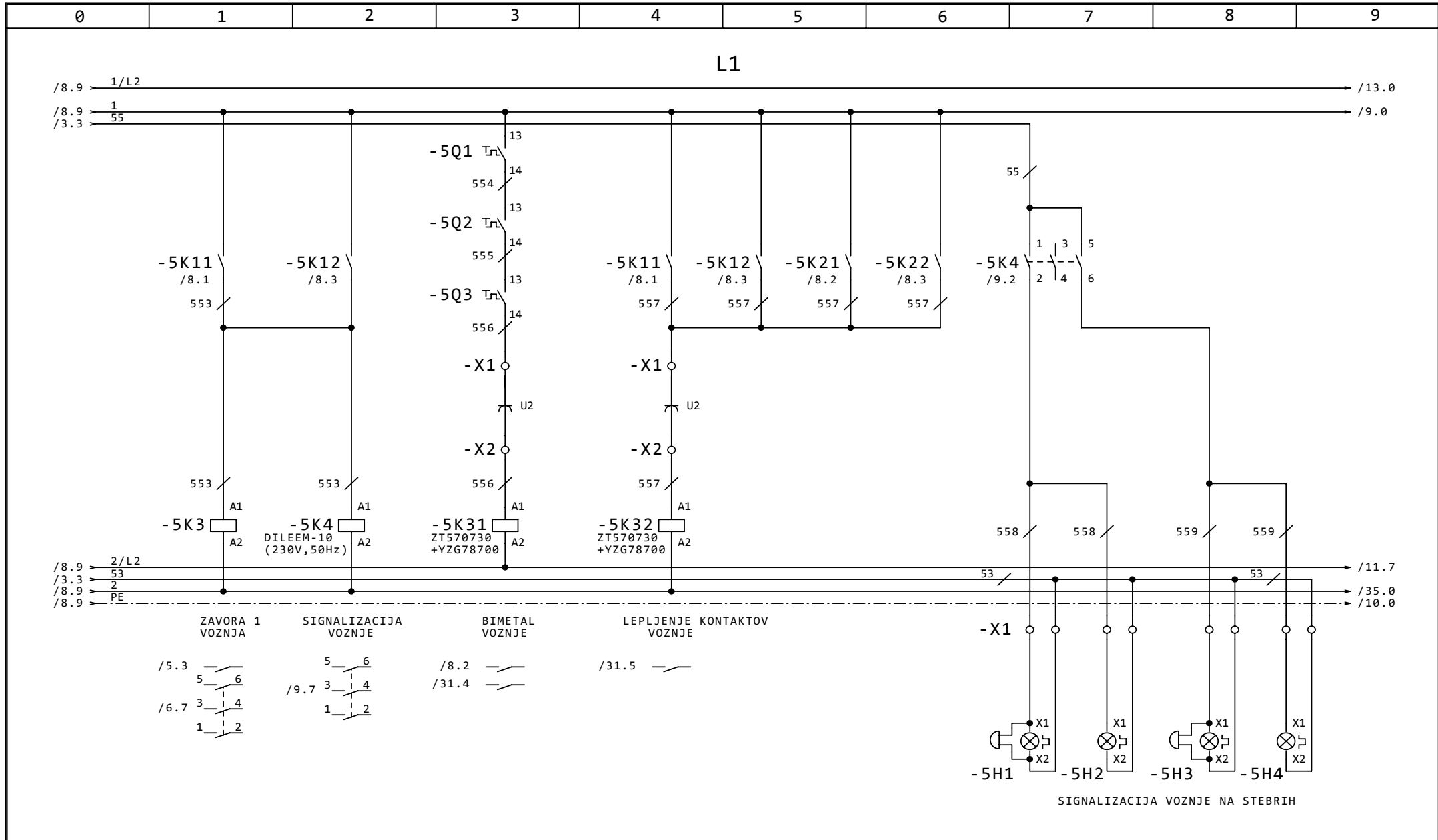

**ROBOTINA d.o.o.**  
 Oprema in sistemi za  
 avtomatizacijo  
 TEL: 066 647 203  
 FAX: 066 648 218

datum	22.12.99	podpis		VRTLJIVI ZERJAV - OD 5	LUKA	VOZNJA DVIĞALA	VOZ	=1
projektiral	Ivan Morano			20/15/10 Mp x 25/30 m	KOPER	KRMILNI DEL V R-L1	+R-L1	
pregledal						St. projekta	stran 9	
verzija	PZI 1.0			objekt	investitor	Skupina	strani 37	
						99060030	-2 -03 -5/3	

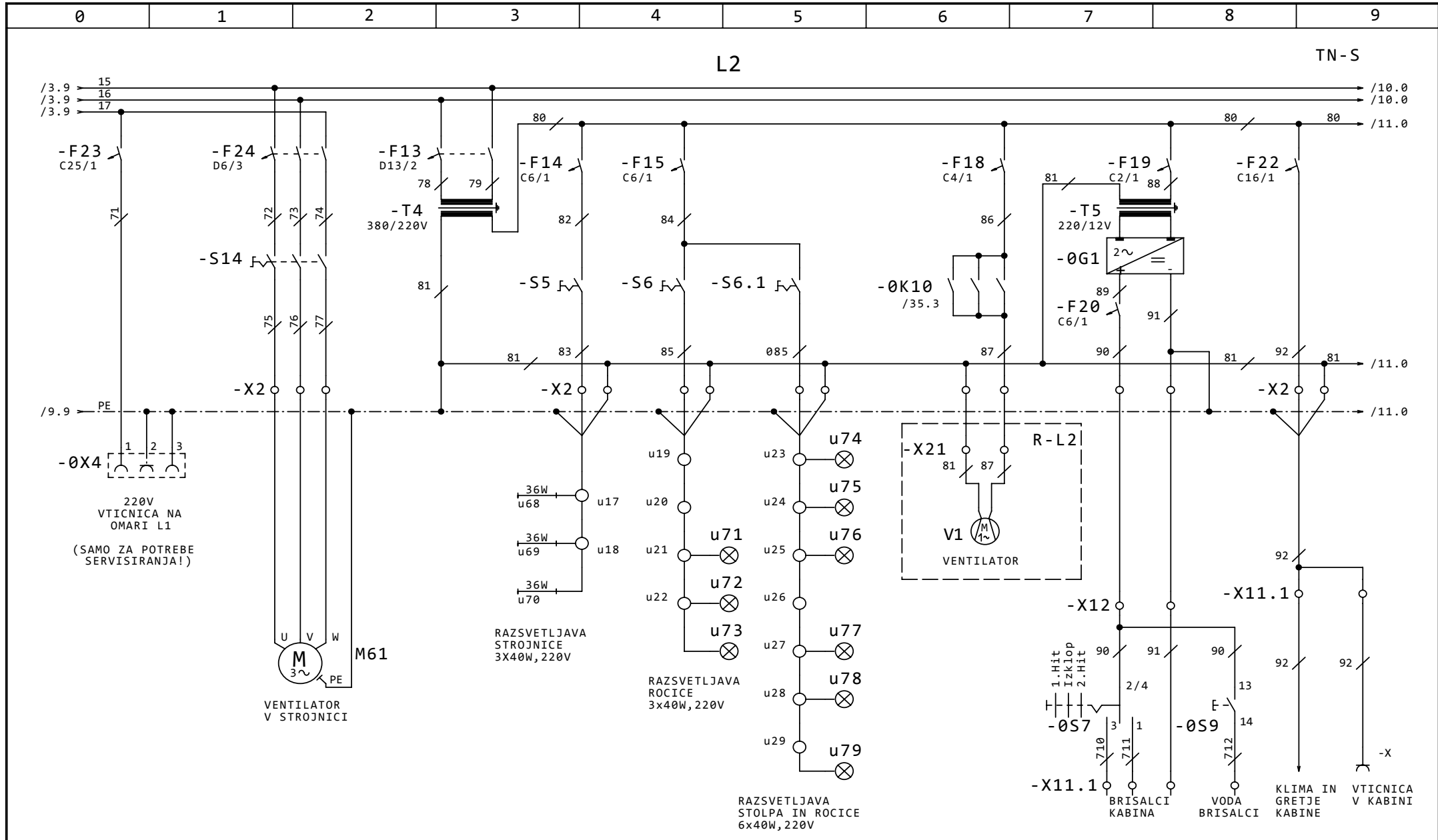

**ROBOTINA d.o.o.**  
Oprema in sistemi za avtomatizacijo  
TEL: 066 647 203  
FAX: 066 648 218

datum	22.12.99	podpis	VRTLJIVI ZERJAV - OD 5	LUKA	POMOZNI TOKOKROG	RAZ	=2
projektiral	Ivan Morano		20/15/10 Mp x 25/30 m	KOPER	RAZSVETLJAVA V OMARI L2		+L2
pregledal			objekt	investitor	St. projekta	Skupina	stran 10
verzija	PZI 1.0				99060030	-2-03-0/4	strani 37

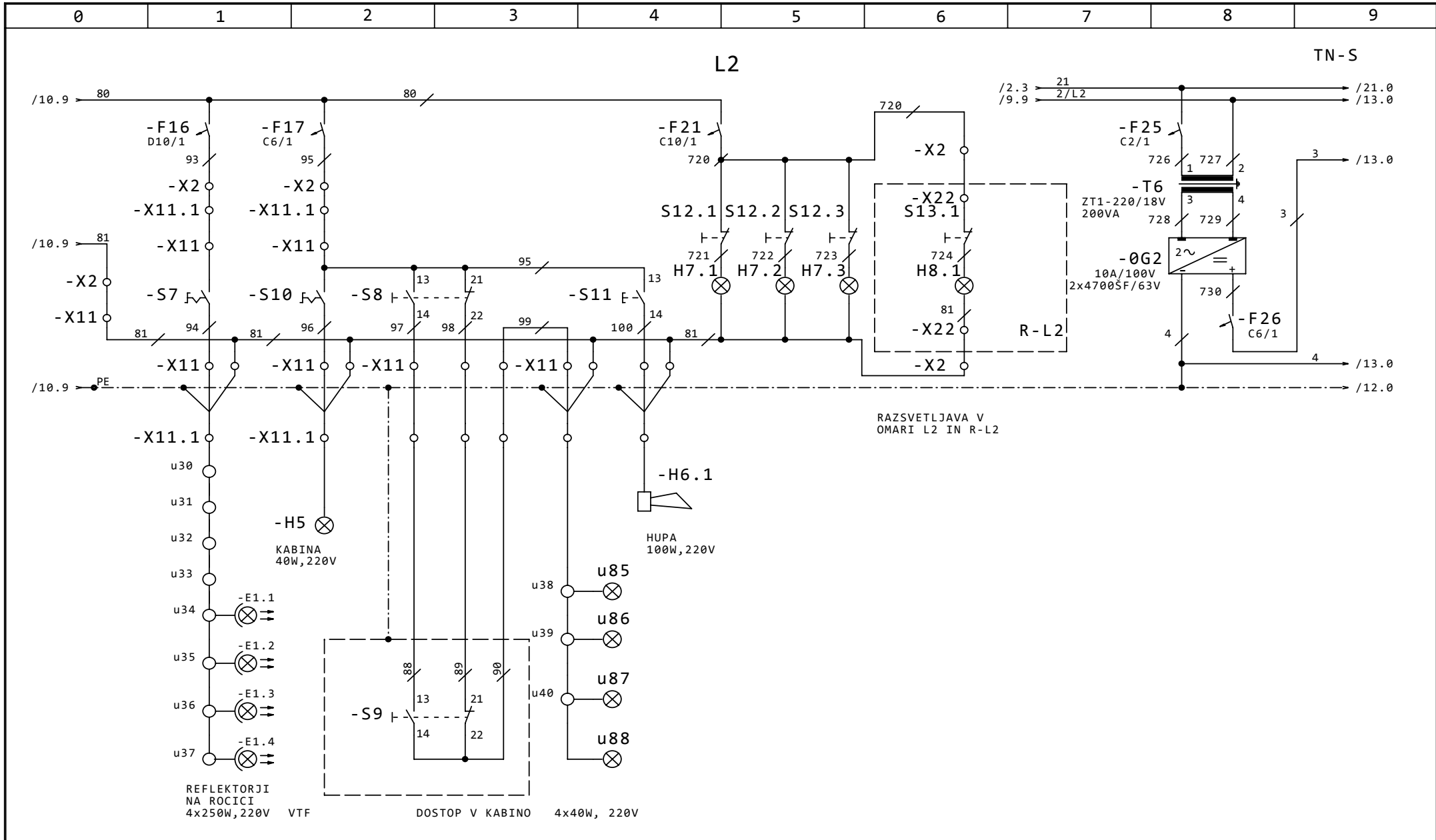

ROBOTINA d.o.o.  
 Oprema in sistemi za  
 avtomatizacijo  
 TEL: 066 647 203  
 FAX: 066 648 218

datum 006.01.100  
 projektiral Ivan Morano  
 pregledal  
 verzija PZI 1.0

podpis

VRTLJIVI ZERJAV - OD 5  
 20/15/10 Mp x 25/30 m  
 objekt

LUKA  
 KOPER  
 investitor

POMOZNI TOKOKROG  
 RAZSVETLJAVA V OMARI 12 in L12  
 St. projekta Skupina  
 99060030 -2 -03 -0/5

RAZ =2  
 +L2  
 stran 11  
 strani 37

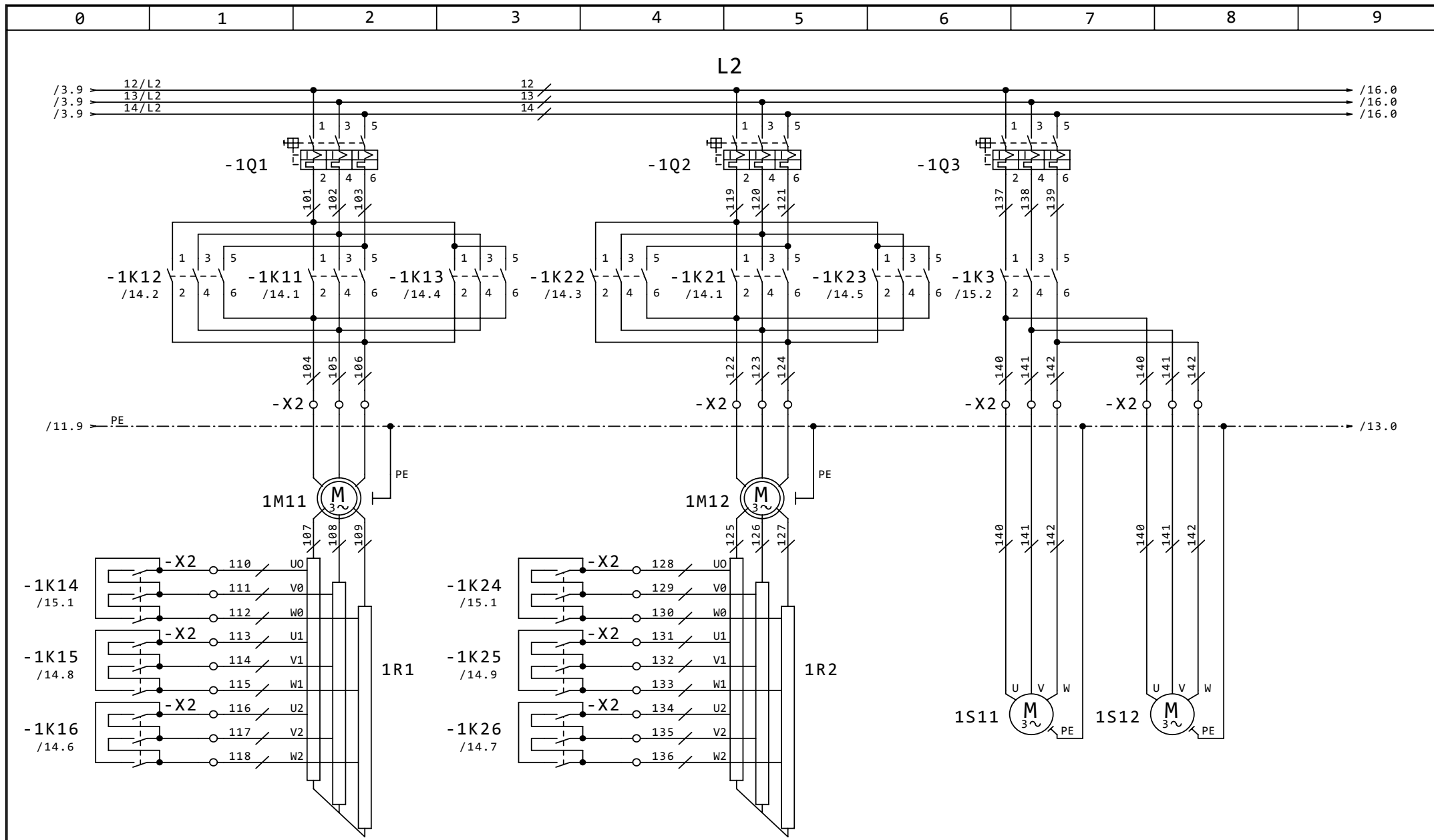

ROBOTINA d.o.o.  
 Oprema in sistemi za  
 avtomatizacijo  
 TEL: 066 647 203  
 FAX: 066 648 218

datum	22.12.99	podpis	VRTLJIVI ZERJAV - OD 5	LUKA	DVIG	DV	=2
projektiral	Ivan Morano		20/15/10 Mp x 25/30 m	KOPER	ENERGETSKI DEL V L2		+L2
pregledal			objekt	investitor	St. projekta	Skupina	stran 12
verzija	PZI 1.0				99060030	-2 -03 -1/1	strani 37

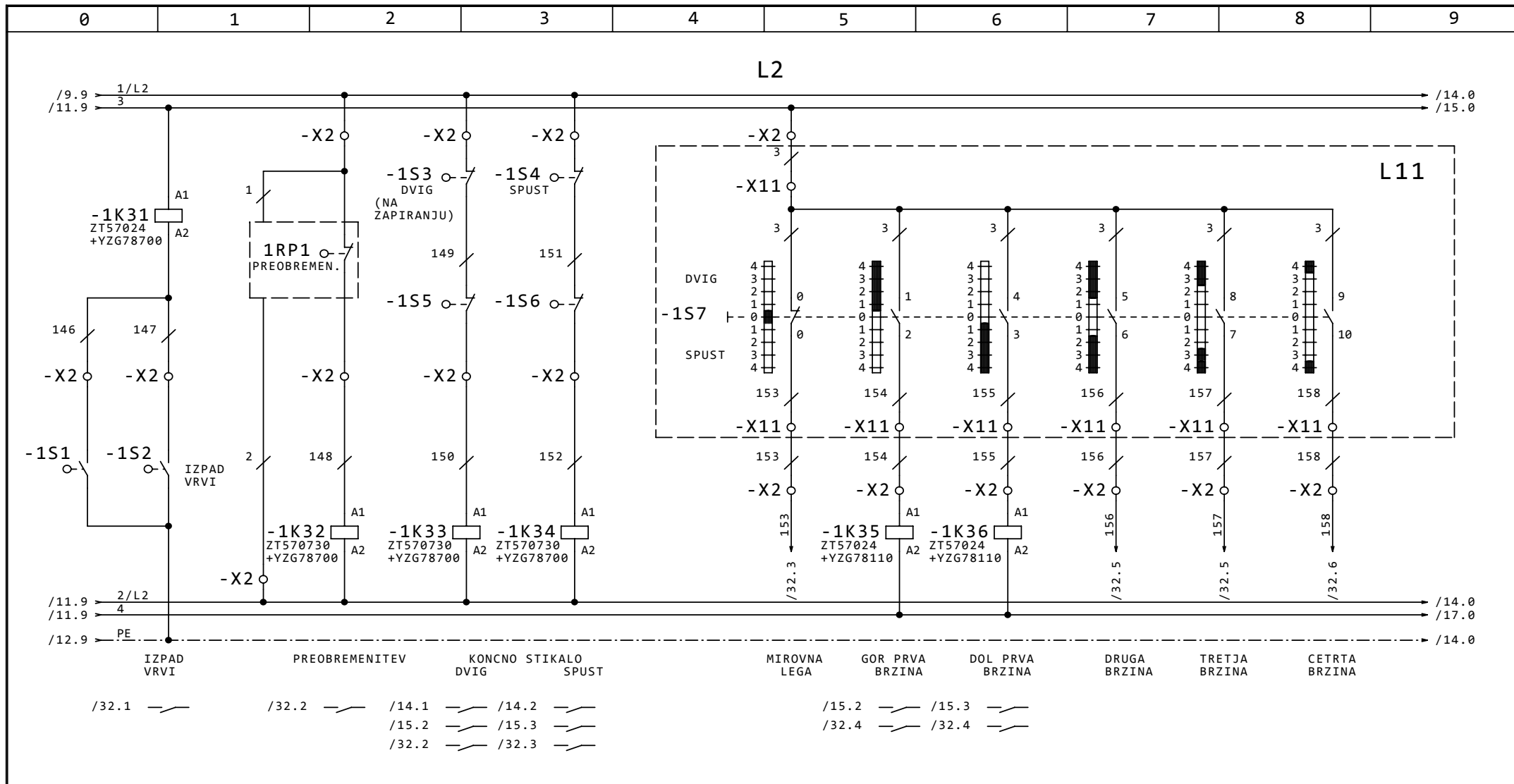

MOJSTRSKO STIKALO DVIGA



ROBOTINA d.o.o.  
 Oprema in sistemi za  
 avtomatizacijo  
 TEL: 066 647 203  
 FAX: 066 648 218

datum	22.12.99
projektiral	Ivan Morano
pregledal	
verzija	PZI 1.0

podpis	
--------	--

VRTLJIVI ZERJAV - OD 5
20/15/10 Mp x 25/30 m
objekt

LUKA
KOPER
investitor

UPRAVLJANJE DVIGA	DV	=2
KRMIJNI DEL V L2 IN PULTU		+L2
St. projekta	Skupina	stran 13
99060030	-2-03-1/2	strani 37

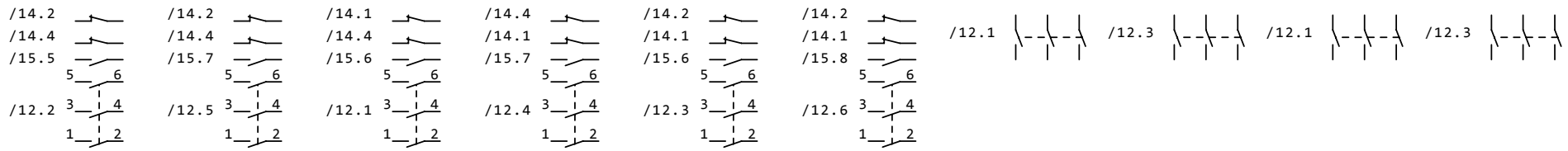
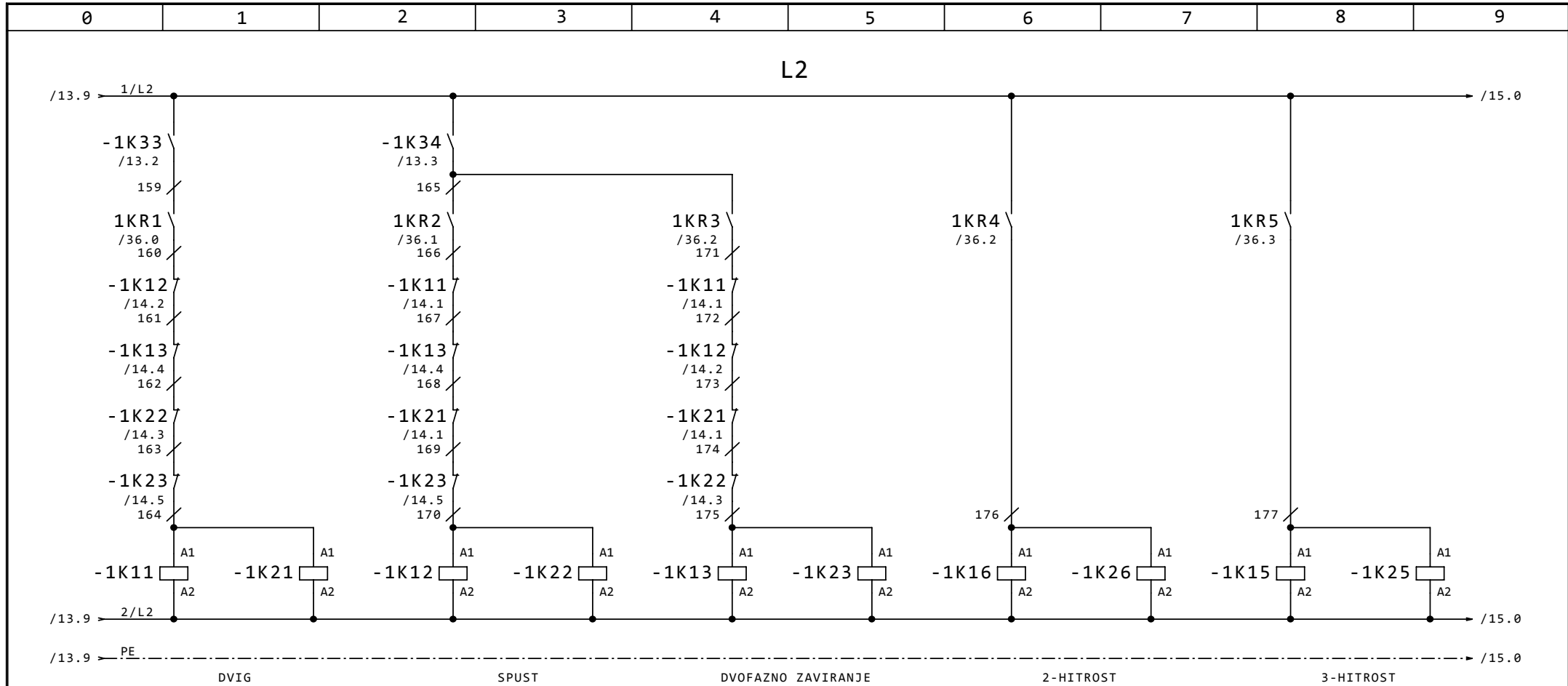

**ROBOTINA d.o.o.**  
 Oprema in sistemi za avtomatizacijo  
 TEL: 066 647 203  
 FAX: 066 648 218

datum	22.12.99
projektiral	Ivan Morano
pregledal	
verzija	PZI 1.0

podpis	
--------	--

VRTLJIVI ZERJAV - OD 5
20/15/10 Mp x 25/30 m
objekt

LUKA
KOPER
investitor

UPRAVLJANJE DVIGA	DV	=2
KRMILNI DEL V L2		
St. projekta	Skupina	
99060030	-2 -03 -1/3	

stran 14
strani 37

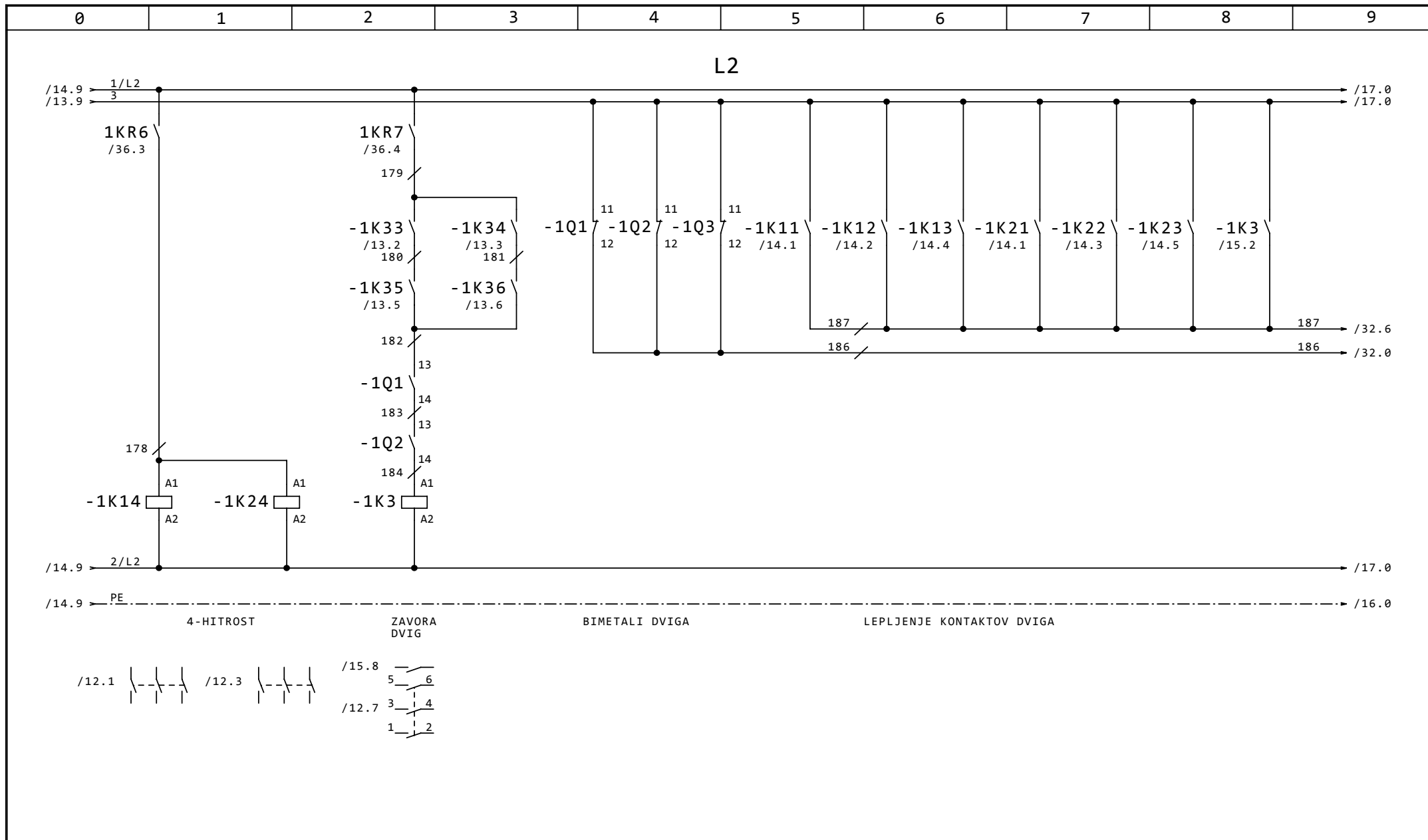

**ROBOTINA d.o.o.**  
 Oprema in sistemi za  
 avtomatizacijo  
 TEL: 066 647 203  
 FAX: 066 648 218

datum	22.12.99	podpis		VRTLJIVI ZERJAV - OD 5	LUKA	UPRAVLJANJE DVIGA	DV	=2
projektiral	Ivan Morano			20/15/10 Mp x 25/30 m	KOPER	KRMILNI DEL V L2		+L2
pregledal				objekt	investitor	St. projekta	Skupina	stran 15
verzija	PZI 1.0					99060030	-2 -03 -1/4	strani 37

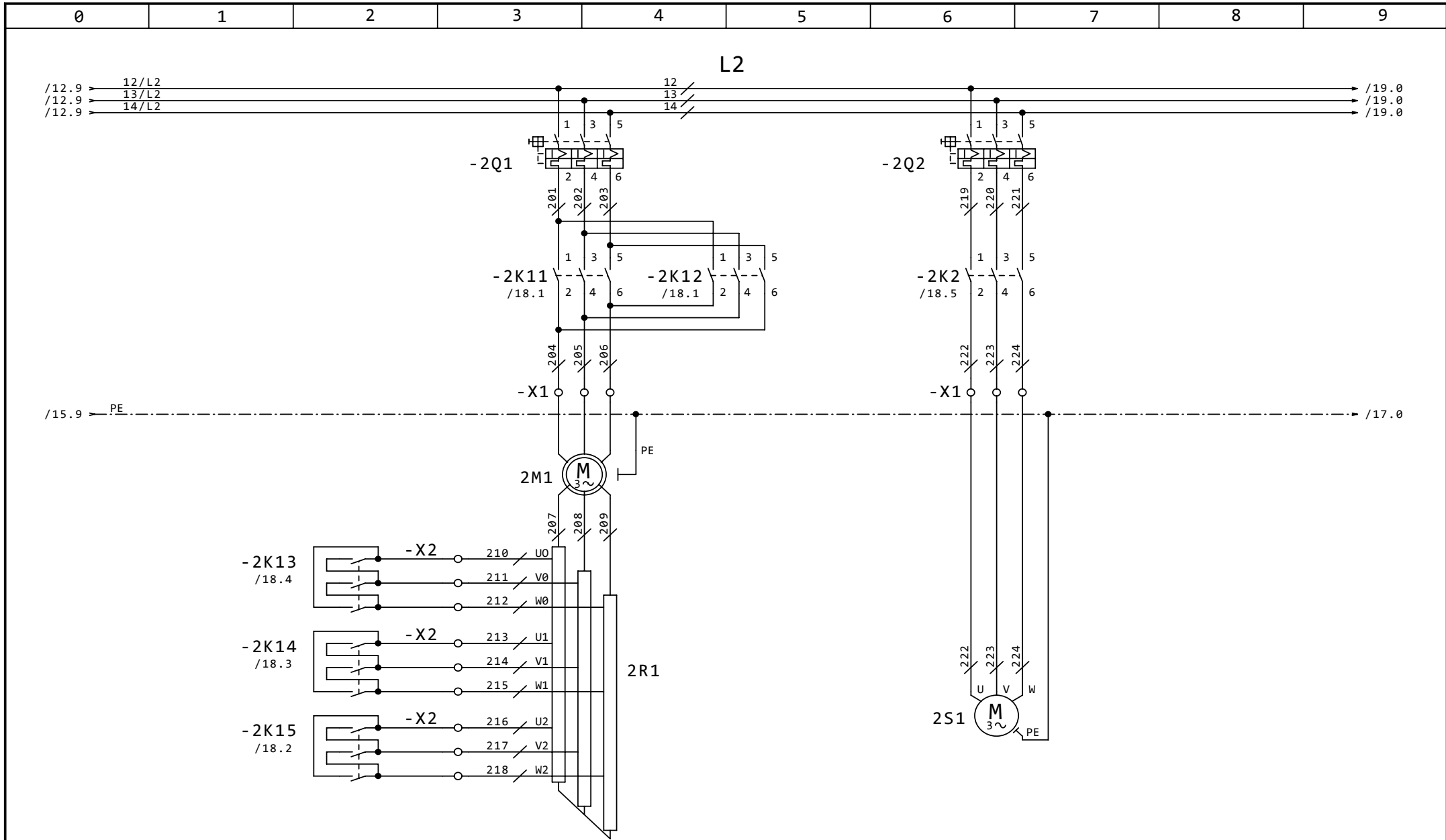

ROBOTINA d.o.o.  
 Oprema in sistemi za  
 avtomatizacijo  
 TEL: 066 647 203  
 FAX: 066 648 218

datum	22.12.99	podpis	VRTLJIVI ZERJAV - OD 5	LUKA	ZAPIRANJE GRABILCA	ZG	=2
projektiral	Ivan Morano		20/15/10 Mp x 25/30 m	KOPER	ENERGETSKI DEL V L2		+L2
pregledal			objekt	investitor	St. projekta	Skupina	stran 16
verzija	PZI 1.0				99060030	-2 -03 -2/1	strani 37



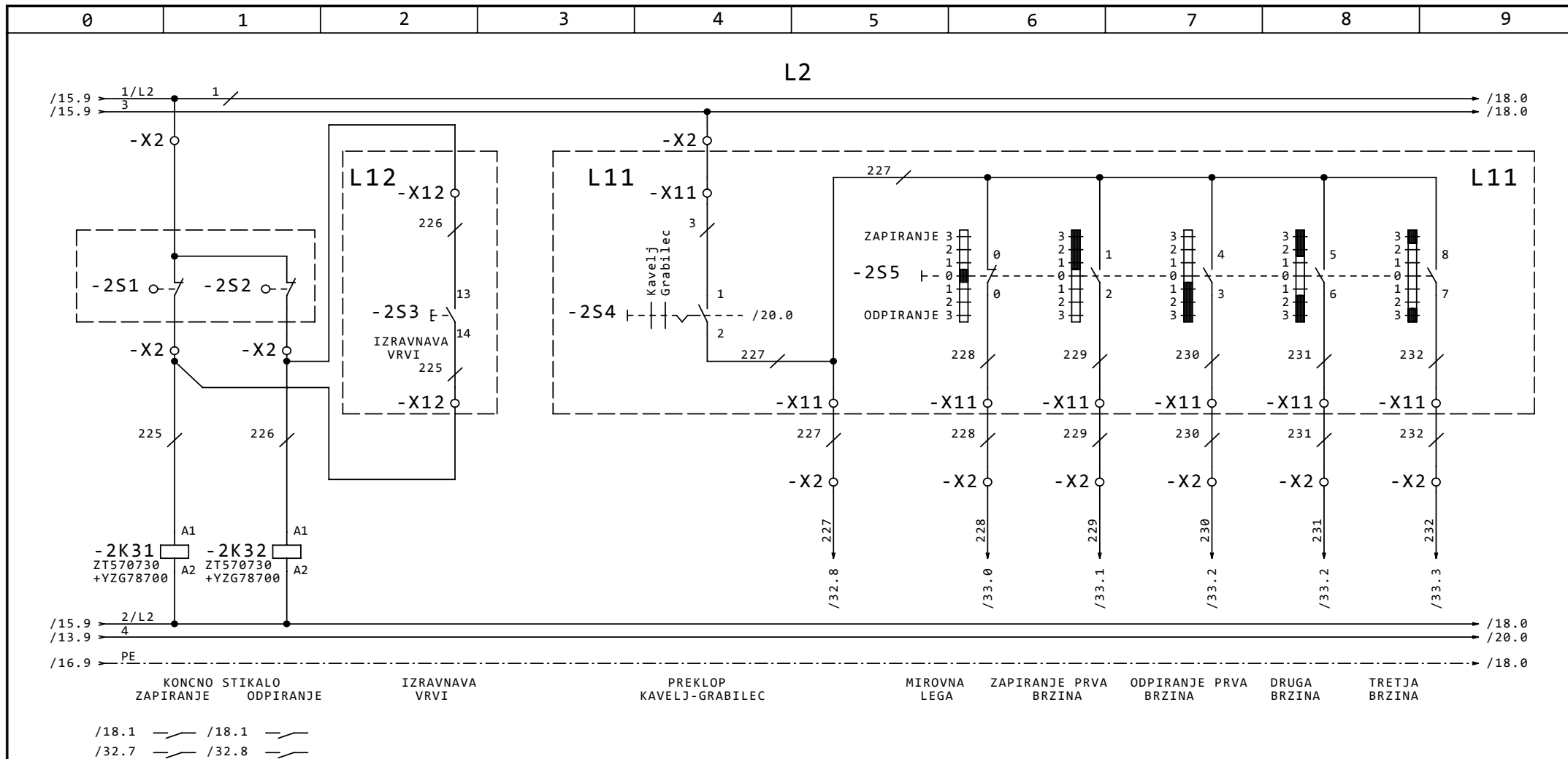

MOJSTRSKO STIKALO GRABILCA



ROBOTINA d.o.o.  
Oprema in sistemi za avtomatizacijo  
TEL: 066 647 203  
FAX: 066 648 218

datum	22.12.99	podpis		VRTLJIVI ZERJAV - OD 5	LUKA	UPRAVLJANJE GRABILCA	ZG	=2
projektiral	Ivan Morano			20/15/10 Mp x 25/30 m	KOPER	KRMILNI DEL V L2		+L2
pregledal				objekt	investitor	St. projekta		stran 17
verzija	PZI 1.0					Skupina	-2 -03 -2/2	strani 37

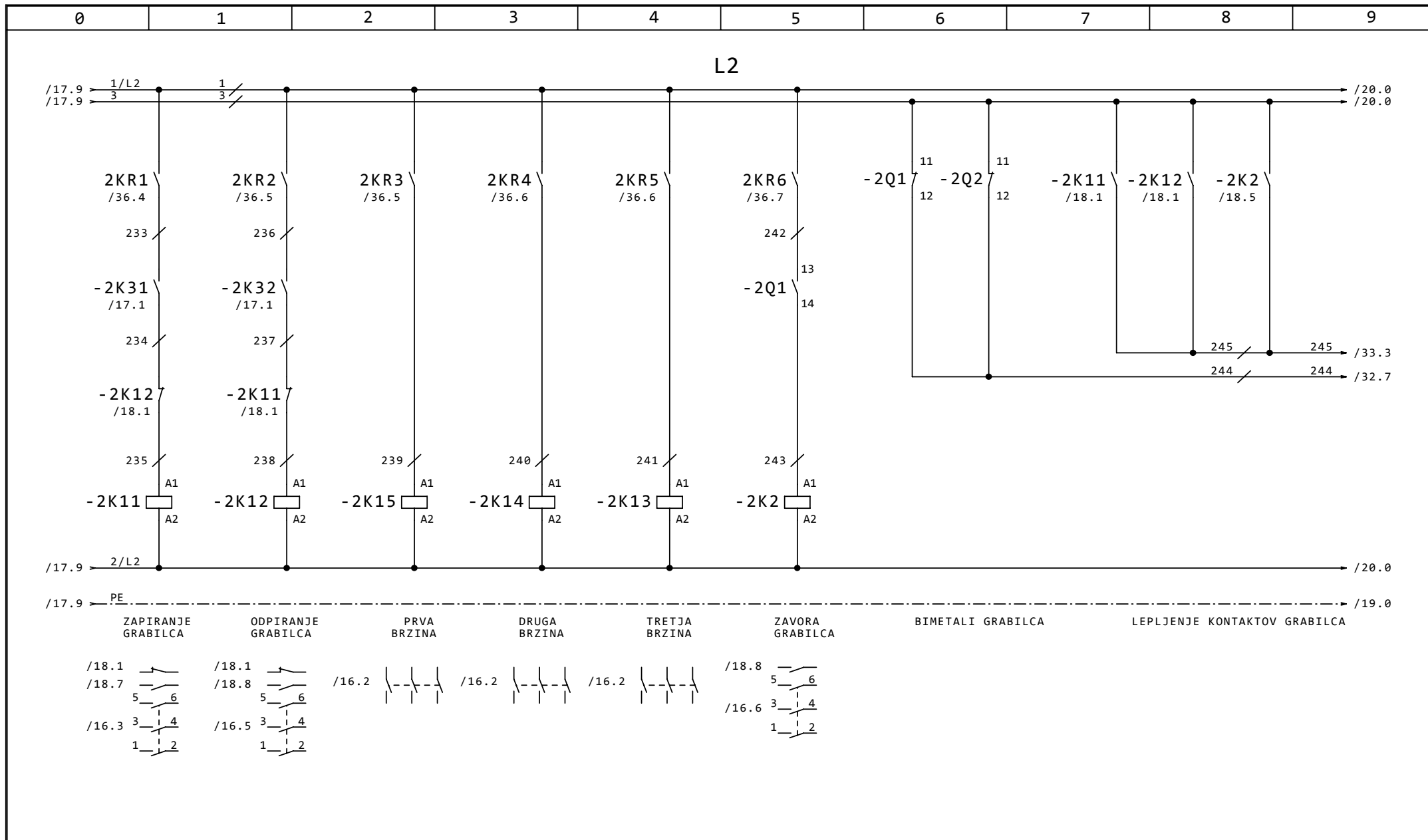

**ROBOTINA d.o.o.**  
 Oprema in sistemi za avtomatizacijo  
 TEL: 066 647 203  
 FAX: 066 648 218

datum	22.12.99	podpis		VRTLJIVI ZERJAV - OD 5	LUKA	UPRAVLJANJE GRABILCA	ZG	=2
projektiral	Ivan Morano			20/15/10 Mp x 25/30 m	KOPER	KRMILNI DEL V L2		+L2
pregledal				objekt	investitor	St. projekta		stran 18
verzija	PZI 1.0					Skupina		strani 37
						99060030	-2 -03 -2/3	

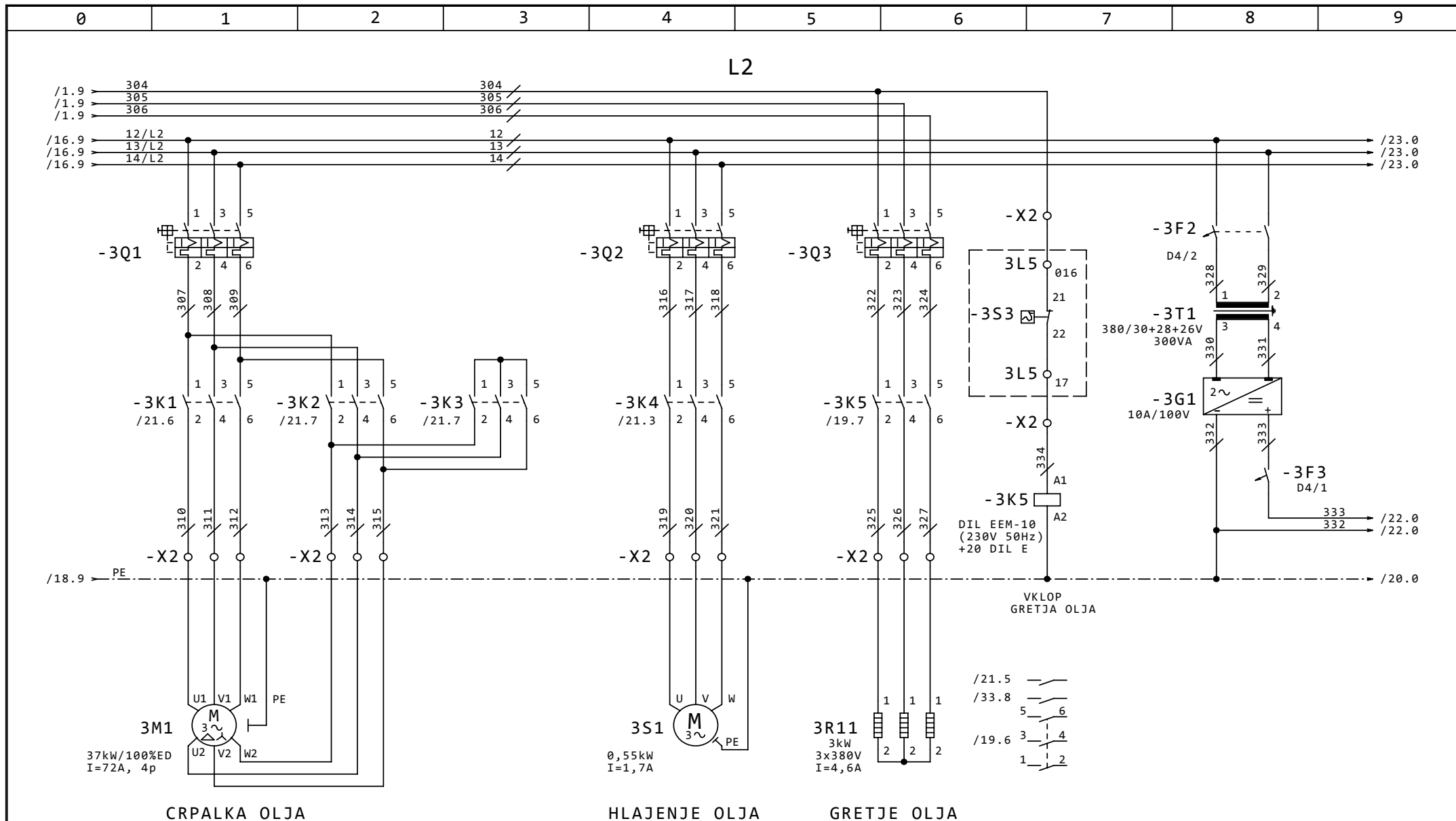

**ROBOTINA d.o.o.**  
 Oprema in sistemi za  
 avtomatizacijo  
 TEL: 066 647 203  
 FAX: 066 648 218

datum	23.12.99	podpis	VRTLJIVI ZERJAV - OD 5	LUKA	NAGIBANJE ROCICE	N	=2
projektiral	Ivan Morano		20/15/10 Mp x 25/30 m	KOPER	ENERGETSKI DEL V L2		+L2
pregledal			objekt	investitor	St. projekta		stran 19
verzija	PZI 1.0				99060030	-2 -03 -3/1	strani 37



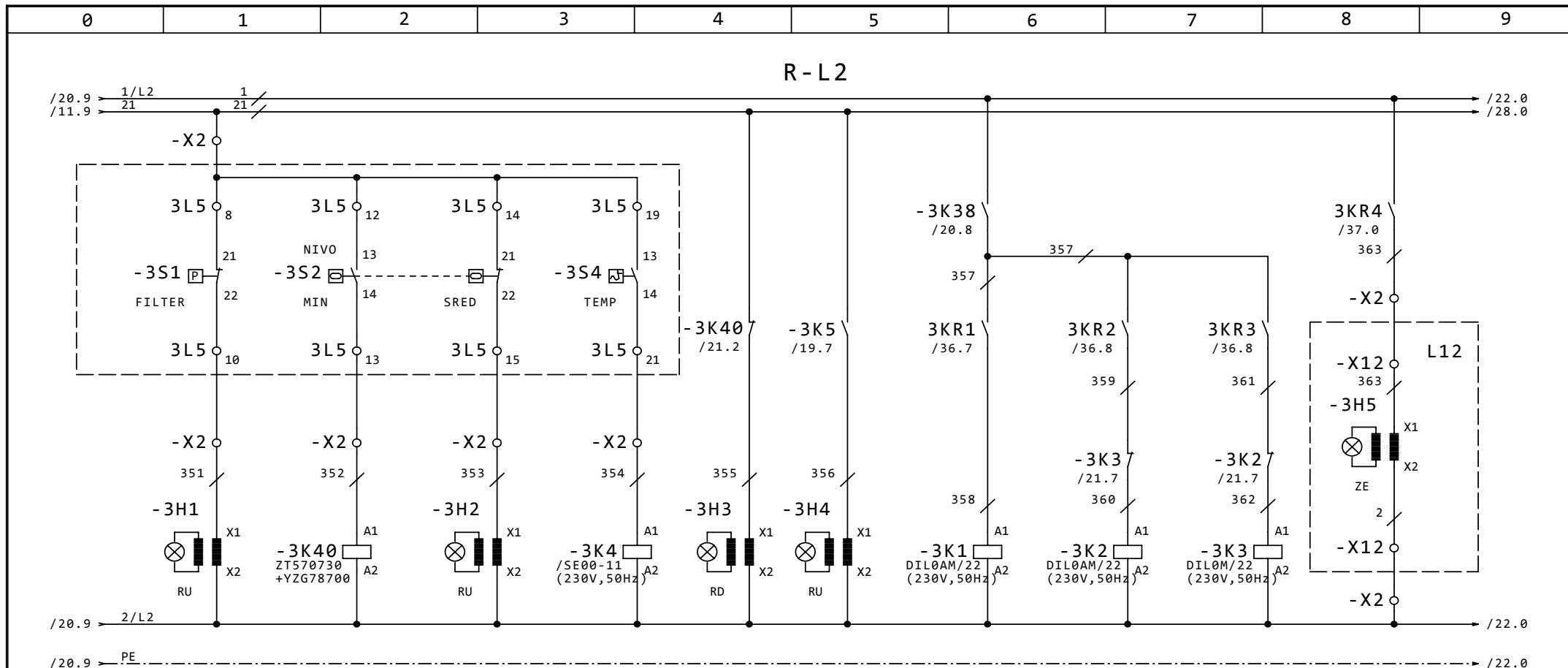

OLJNI FILTER UMAZAN      NIVO OLJA IZKLOP      NIVO OLJA OPOZORILO      HLAJENJE OLJA      NIVO OLJA IZKLOP      GRETELJE OLJA      CRPALKA OLJA VKLOP      CRPALKA OLJA TRIKOT      CRPALKA OLJA ZVEZDA      DELOVANJE CRPALKE/NAPAKA NAGIBANJA



**ROBOTINA d.o.o.**  
 Oprema in sistemi za avtomatizacijo  
 TEL: 066 647 203  
 FAX: 066 648 218

datum	05.01.100	podpis
projektiral	Ivan Morano	
pregledal		
verzija	PZI 1.0	

objekt	VRTLJIVI ZERJAV - OD 5 20/15/10 Mp x 25/30 m
--------	---

investitor	LUKA KOPER
------------	---------------

St. projekta	99060030	Skupina	-2 -03 -3/4
--------------	----------	---------	-------------

N	=2
	+R-L2
	stran 21
	strani 37

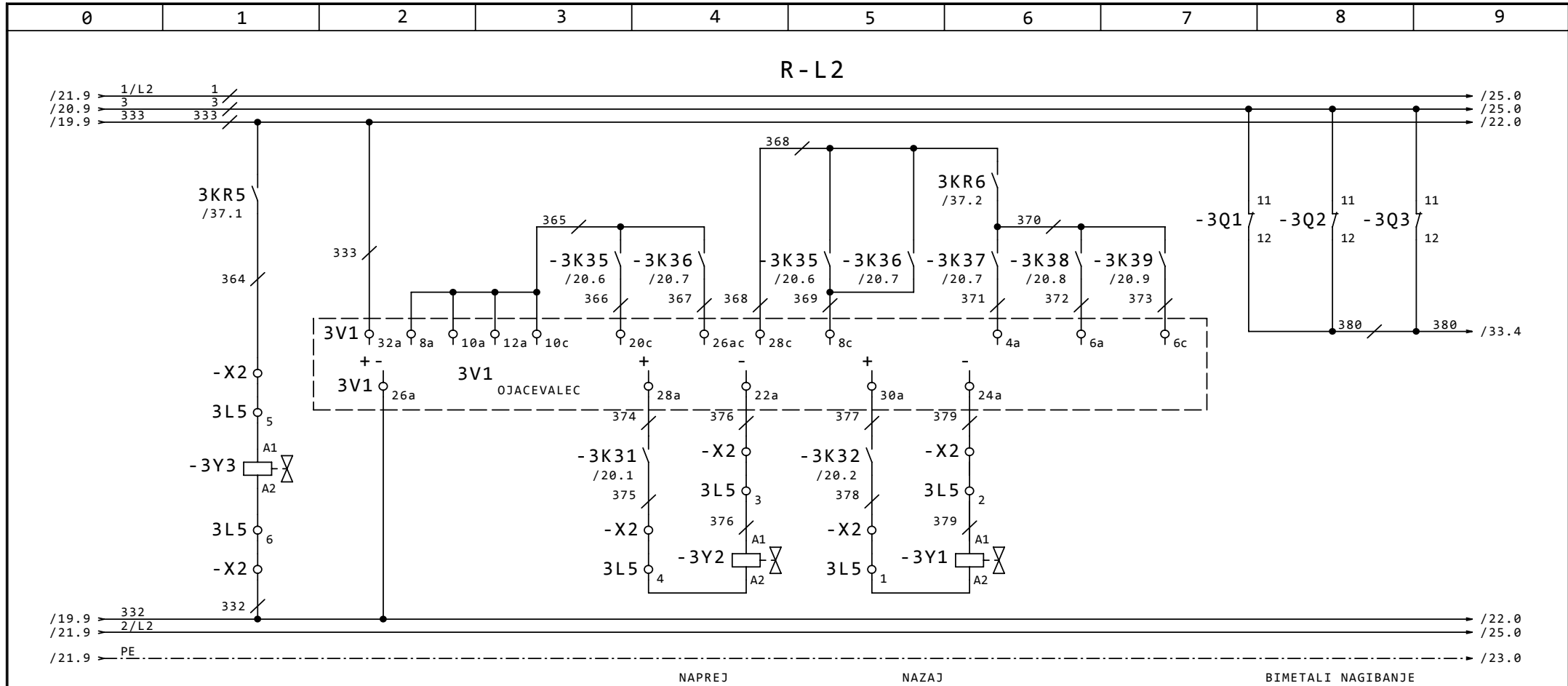

**ROBOTINA d.o.o.**  
 Oprema in sistemi za  
 avtomatizacijo  
 TEL: 066 647 203  
 FAX: 066 648 218

datum	22.12.99	podpis		VRTLJIVI ZERJAV - OD 5	LUKA	UPRAVLJANJE NAGIBANJA ROCICE	N	=2
projektiral	Ivan Morano			20/15/10 Mp x 25/30 m	KOPER	KRMILNI DEL V L2		+L2
pregledal				objekt	investitor	St. projekta	Skupina	stran 22
verzija	PZI 1.0					99060030	-2 -03 -3/5	strani 37

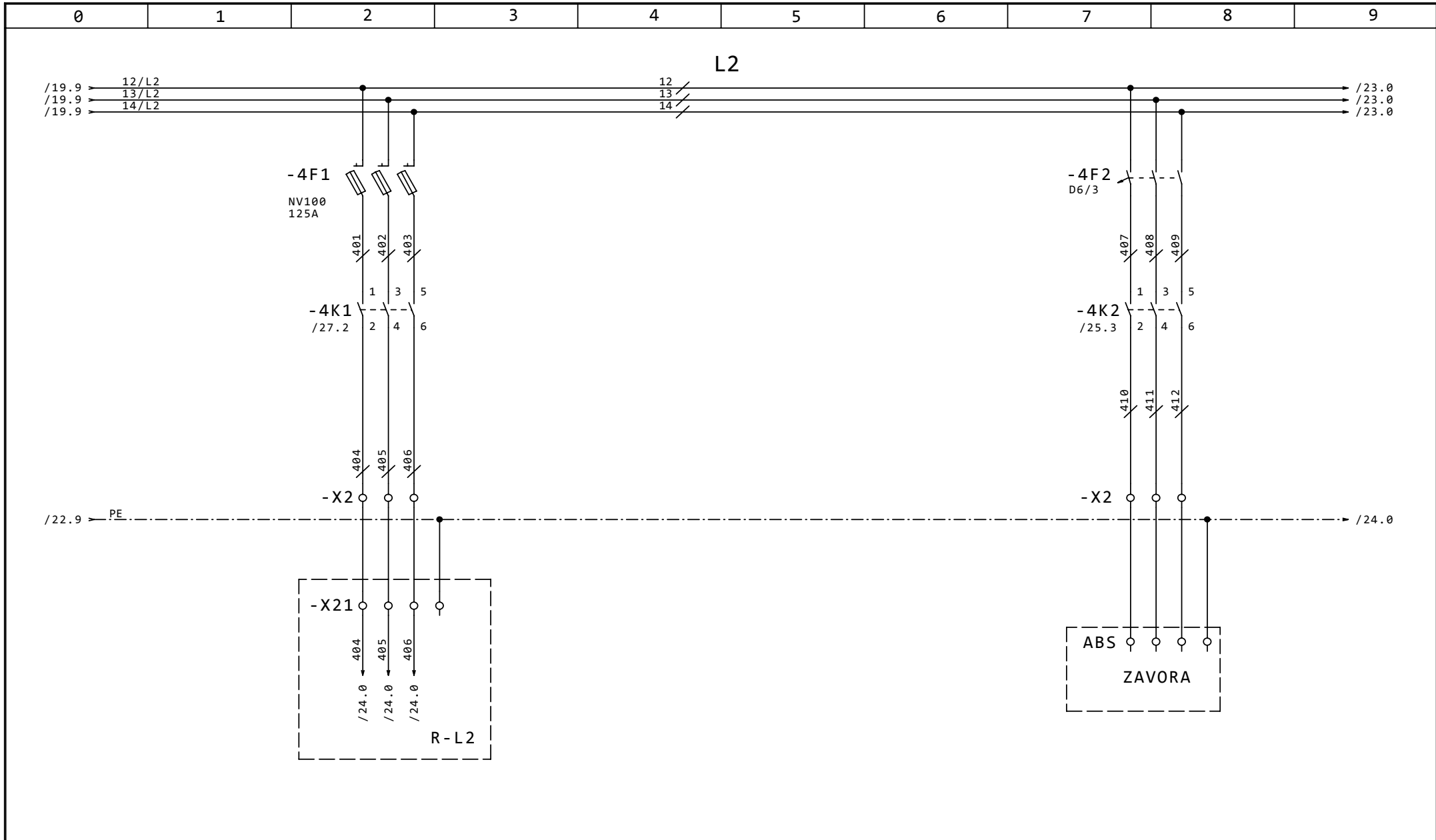

ROBOTINA d.o.o.  
 Oprema in sistemi za  
 avtomatizacijo  
 TEL: 066 647 203  
 FAX: 066 648 218

datum	05.01.100	podpis
projektiral	Ivan Morano	
pregledal		
verzija	PZI 1.0	

VRTLJIVI ZERJAV - OD 5  
 20/15/10 Mp x 25/30 m  
 objekt

LUKA  
 KOPER  
 investitor

OBRACANJE  
 ENERGETSKI DEL V L2  
 St. projekta 99060030  
 Skupina -2 -03 -4/1

OB	=2
	+L2
	stran 23
	strani 37

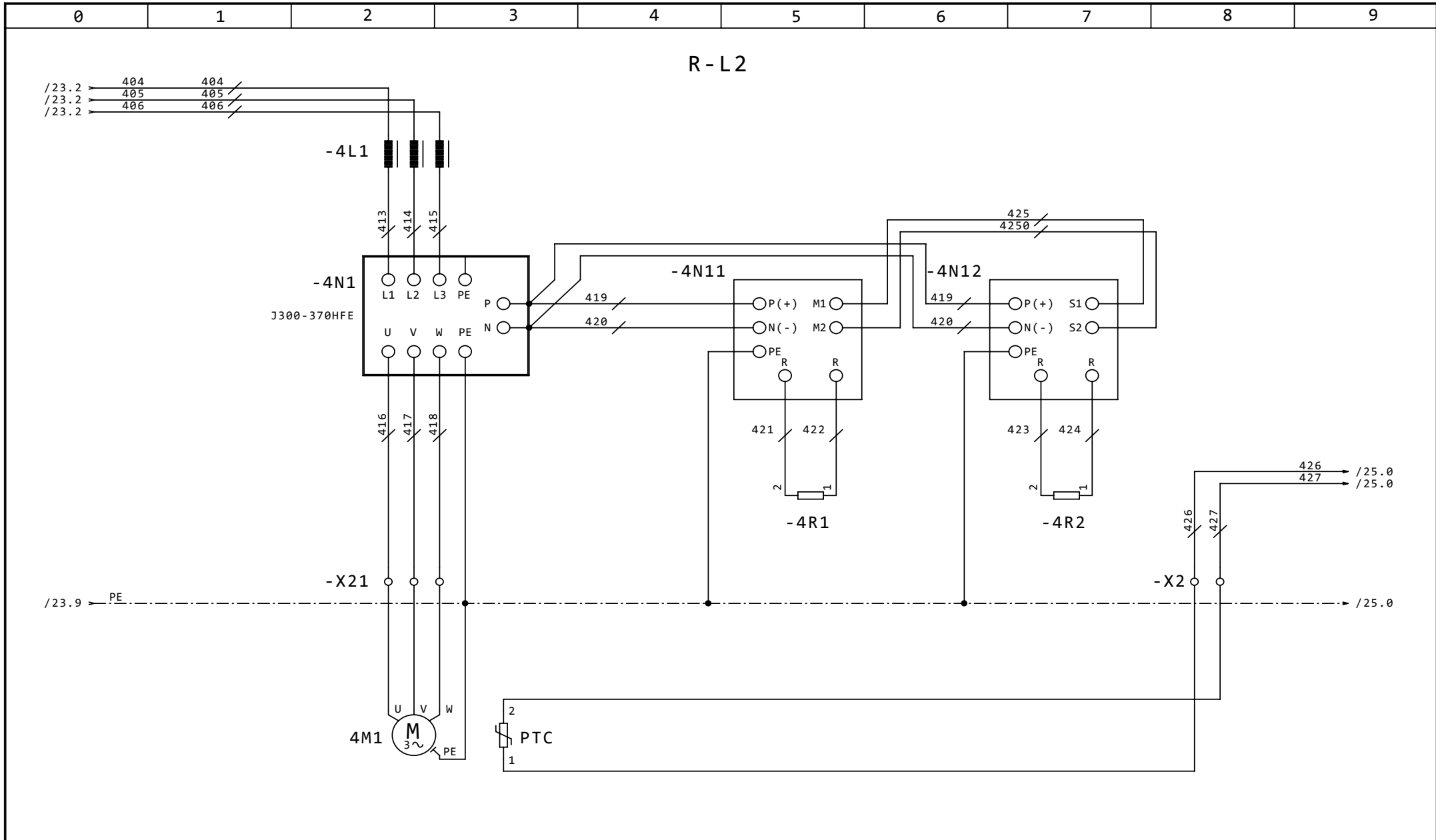

**ROBOTINA d.o.o.**  
 Oprema in sistemi za  
 avtomatizacijo  
 TEL: 066 647 203  
 FAX: 066 648 218

datum	22.12.99	podpis		VRTLJIVI ZERJAV - OD 5	LUKA	OBRACANJE		OB	=2
projektiral	Ivan Morano			20/15/10 Mp x 25/30 m	KOPER	ENERGETSKI DEL V R-L2			+R-L2
pregledal				objekt	investitor	St. projekta	Skupina		stran 24
verzija	PZI 1.0					99060030	-2 -03 -4/2		strani 37



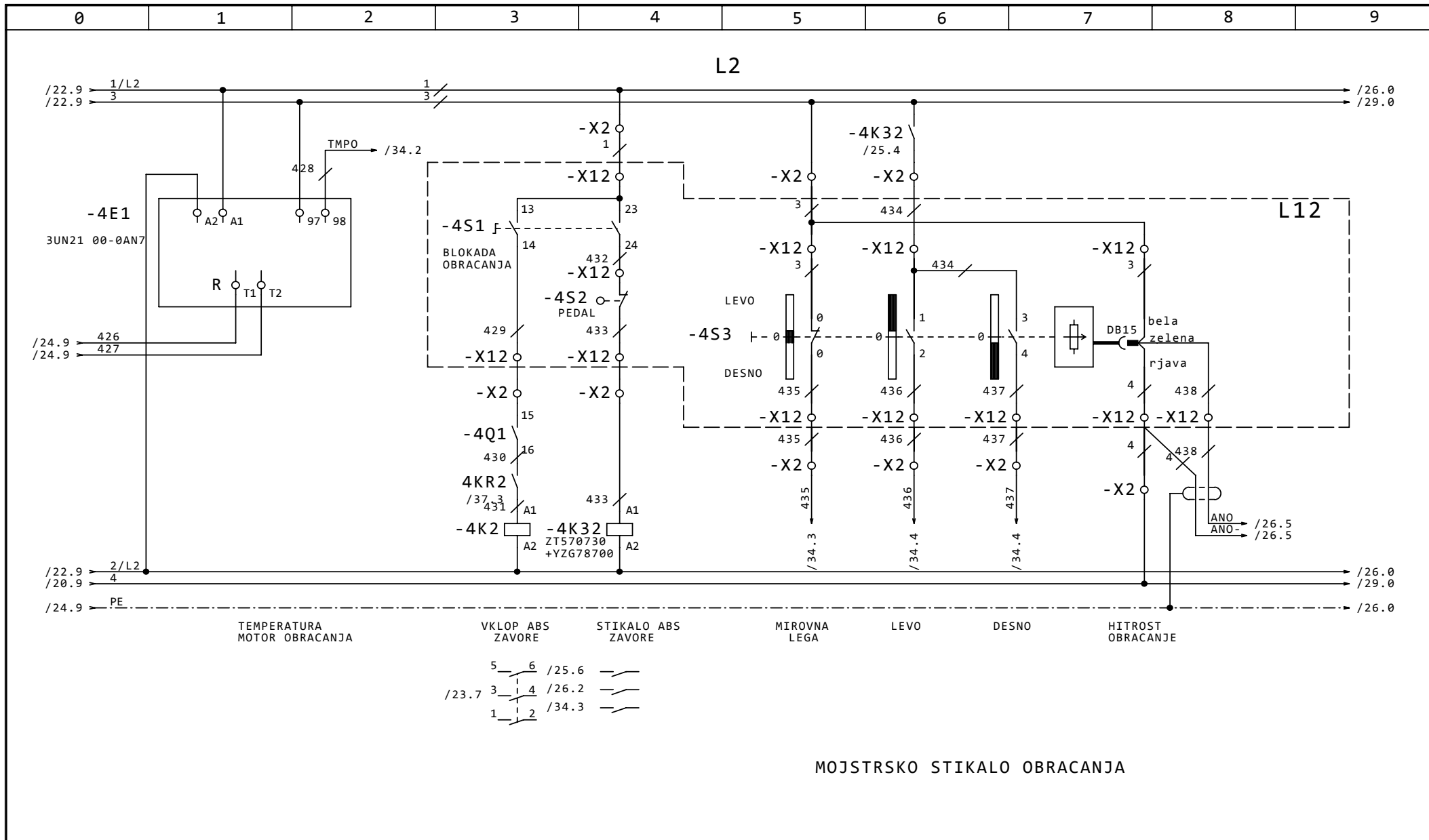

	ROBOTINA d.o.o.	datum	22.12.99	podpis	VRTLJIVI ZERJAV - OD 5	LUKA	UPRAVLJANJE OBRACANJA	OB	=2
	Oprema in sistemi za avtomatizacijo		projektiral	Ivan Morano	20/15/10 Mp x 25/30 m	KOPER	KRMILNI DEL V L2		+L2
	TEL: 066 647 203		pregledal		objekt	investitor	St. projekta	Skupina	stran 25
	FAX: 066 648 218		verzija	PZI 1.0			99060030	-2 -03 -4/3	strani 37

0	1	2	3	4	5	6	7	8	9
---	---	---	---	---	---	---	---	---	---

### R-L2

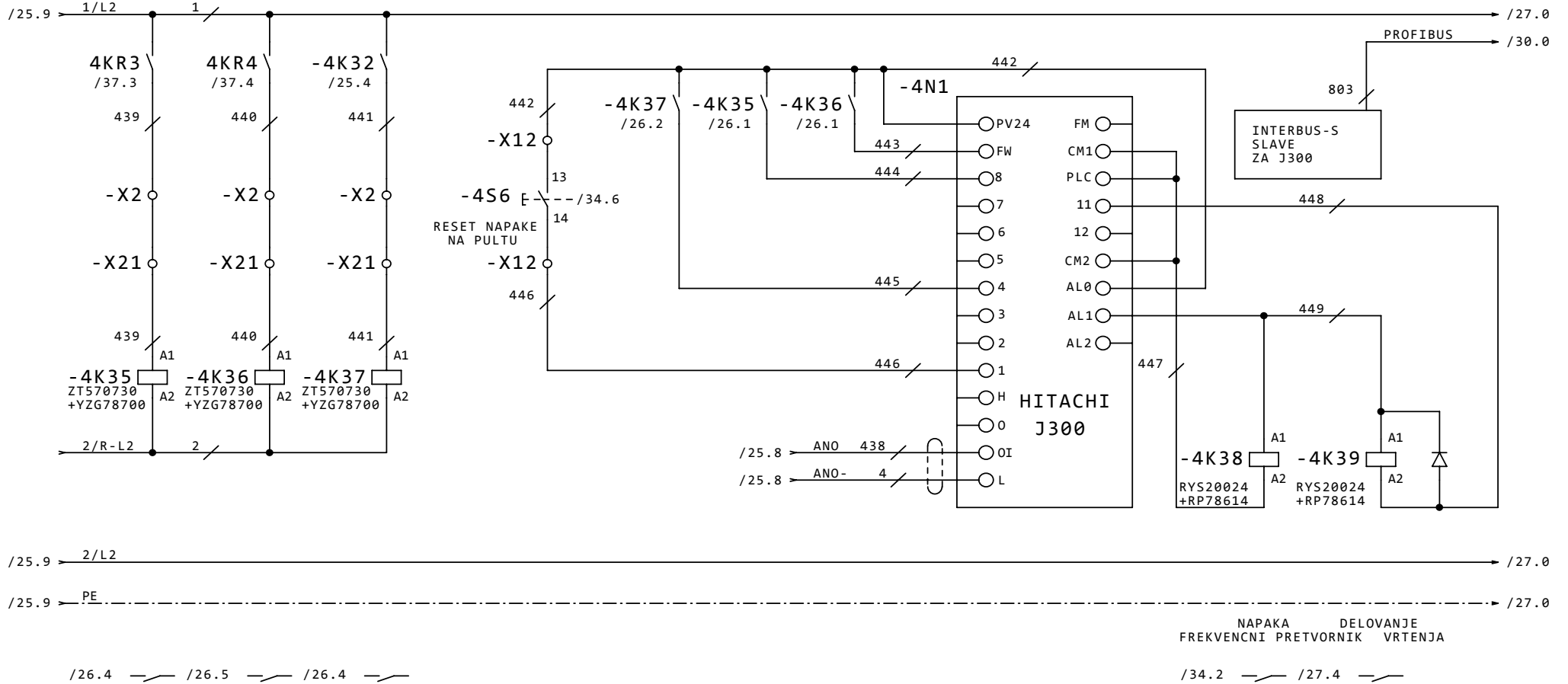

<p>ROBOTINA d.o.o. Oprema in sistemi za avtomatizacijo TEL: 066 647 203 FAX: 066 648 218</p>	datum	22.12.99	podpis	<b>VRTLJIVI ZERJAV - OD 5</b> <b>20/15/10 Mp x 25/30 m</b> objekt	<b>LUKA</b> <b>KOPER</b> investitor	OBRACANJE	<b>OB</b> =2 +R-L2 stran 26 strani 37	
	projektiral	Ivan Morano				St. projekta		Skupina
	pregledal					99060030		-2 -03 -4/4
	verzija	PZI 1.0						

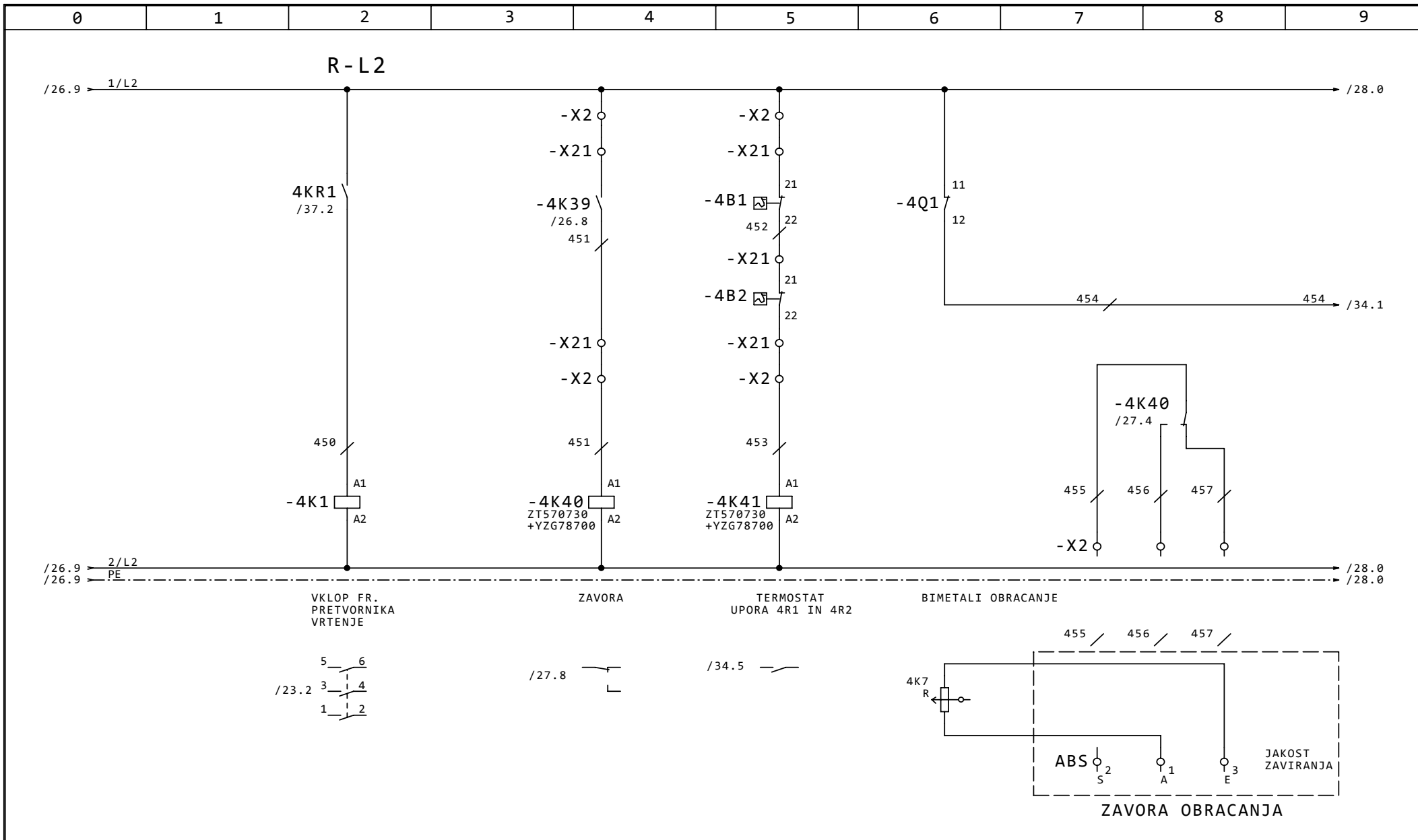

 <b>ROBOTINA d.o.o.</b> Oprema in sistemi za avtomatizacijo TEL: 066 647 203 FAX: 066 648 218	datum	22.12.99	podpis	<b>VRTLJIVI ZERJAV - OD 5</b> <b>20/15/10 Mp x 25/30 m</b> objekt	<b>LUKA KOPER</b> investitor	UPRAVLJANJE OBRACANJA	<b>OB</b> =2 +L2 stran 27 strani 37	
	projektiral	Ivan Morano				99060030		
	pregledal					St. projekta		Skupina
	verzija	PZI 1.0				99060030		-2 -03 -4/5



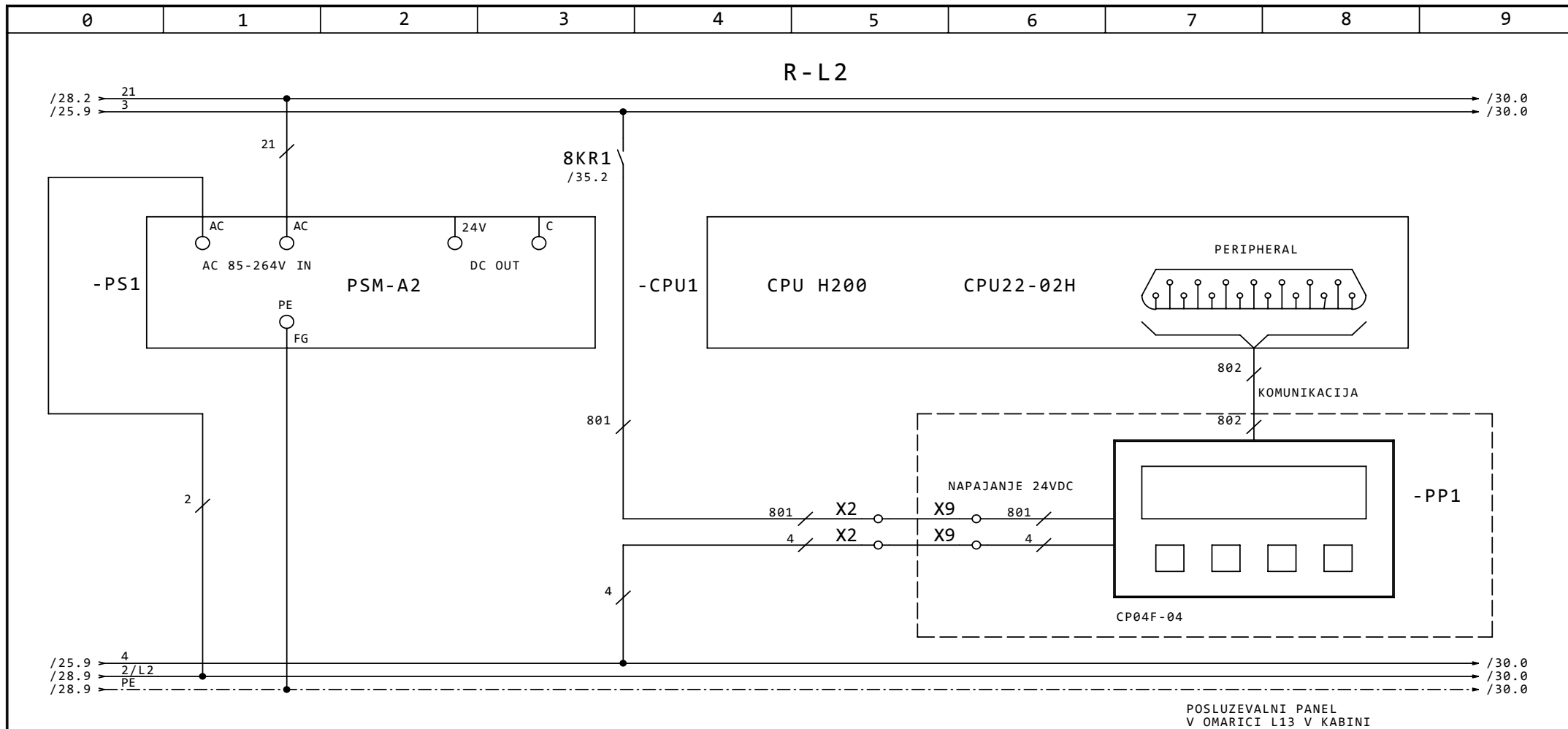

POSLUZEVALNI PANEL  
V OMARICI L13 V KABINI



**ROBOTINA d.o.o.**  
Oprema in sistemi za  
avtomatizacijo  
TEL: 066 647 203  
FAX: 066 648 218

datum	22.12.99
projektiral	Ivan Morano
pregledal	
verzija	PZI 1.0

podpis	
--------	--

VRTLJIVI ZERJAV - OD 5 20/15/10 Mp x 25/30 m
objekt

LUKA KOPER
investitor

PLC KRMILNIK SKUPNI DEL V L2	
St. projekta	Skupina
99060030	-2 -03 -8/1

PLC	=2 +L2
	stran 29
	strani 37

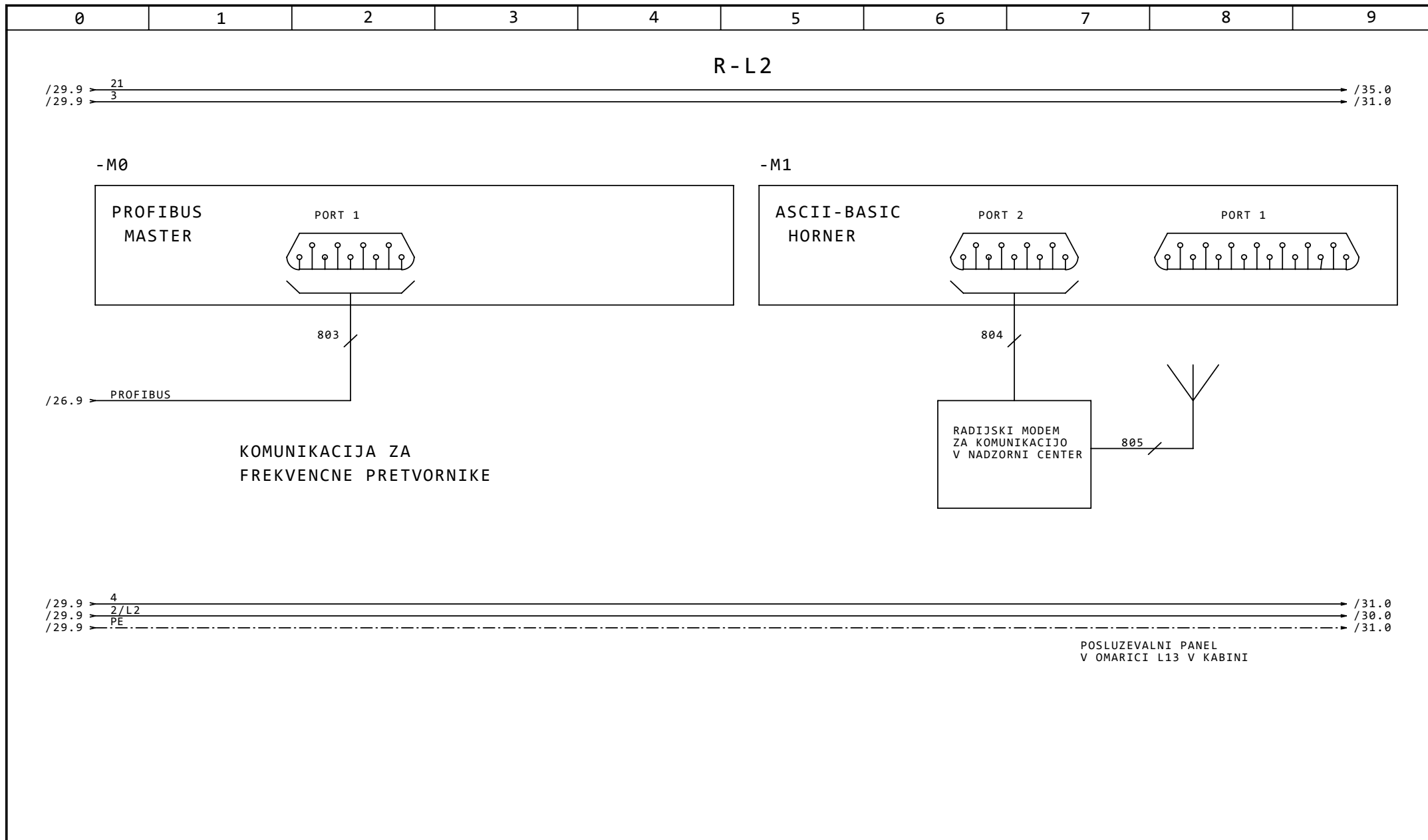

**ROBOTINA d.o.o.**  
 Oprema in sistemi za avtomatizacijo  
 TEL: 066 647 203  
 FAX: 066 648 218

datum	22.12.99	podpis		VRTLJIVI ZERJAV - OD 5	LUKA	PLC KRMILNIK	PLC	=2
projektiral	Ivan Morano			20/15/10 Mp x 25/30 m	KOPER	SKUPNI DEL V L2		+L2
pregledal						St. projekta		stran 30
verzija	PZI 1.0			objekt	investitor	Skupina	-2 -03 -8/2	strani 37
						99060030		

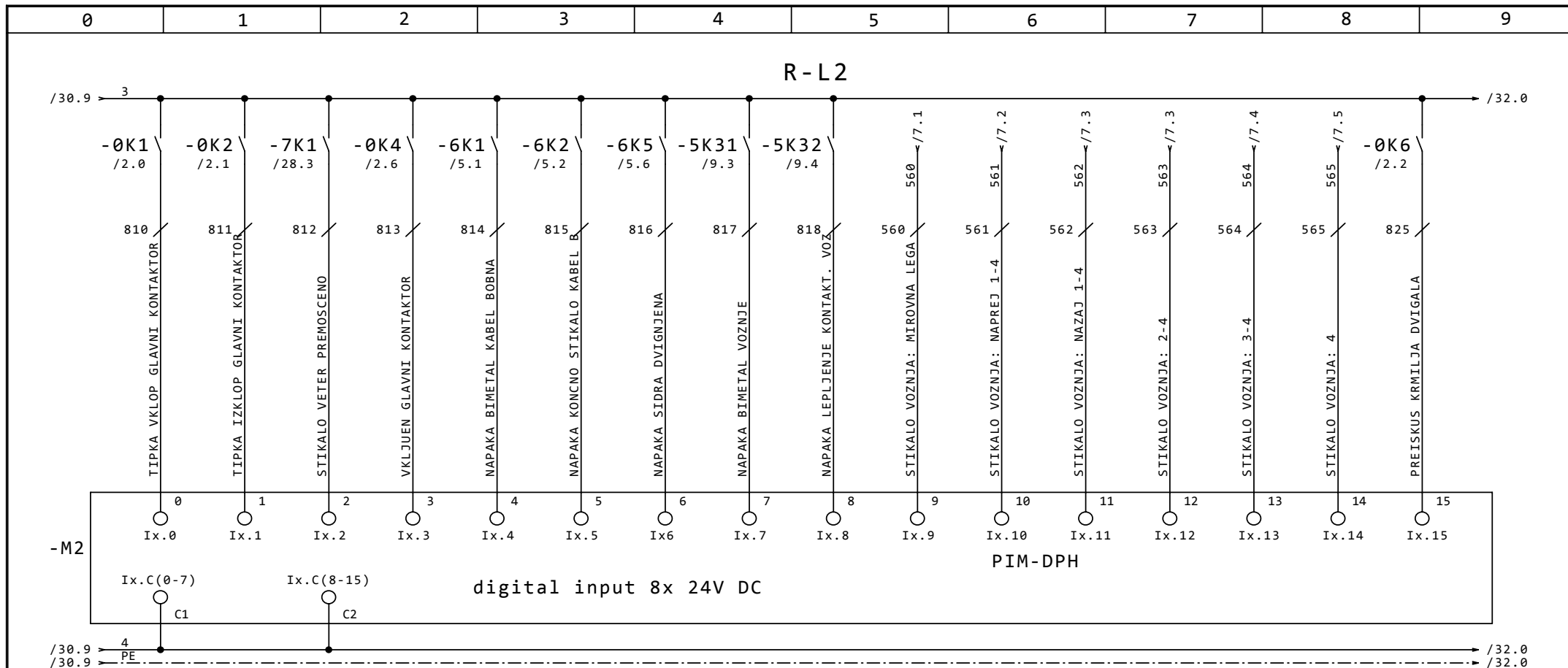

**ROBOTINA d.o.o.**  
 Oprema in sistemi za  
 avtomatizacijo  
 TEL: 066 647 203  
 FAX: 066 648 218

datum	22.12.99	podpis		VRTLJIVI ZERJAV - OD 5	LUKA	PLC KRMILNIK	PLC	=2
projektiral	Ivan Morano			20/15/10 Mp x 25/30 m	KOPER	SKUPNI DEL V L2		+L2
pregledal						St. projekta		stran 31
verzija	PZI 1.0			objekt	investitor	Skupina		strani 37
						99060030	-2 -03 -8/3	

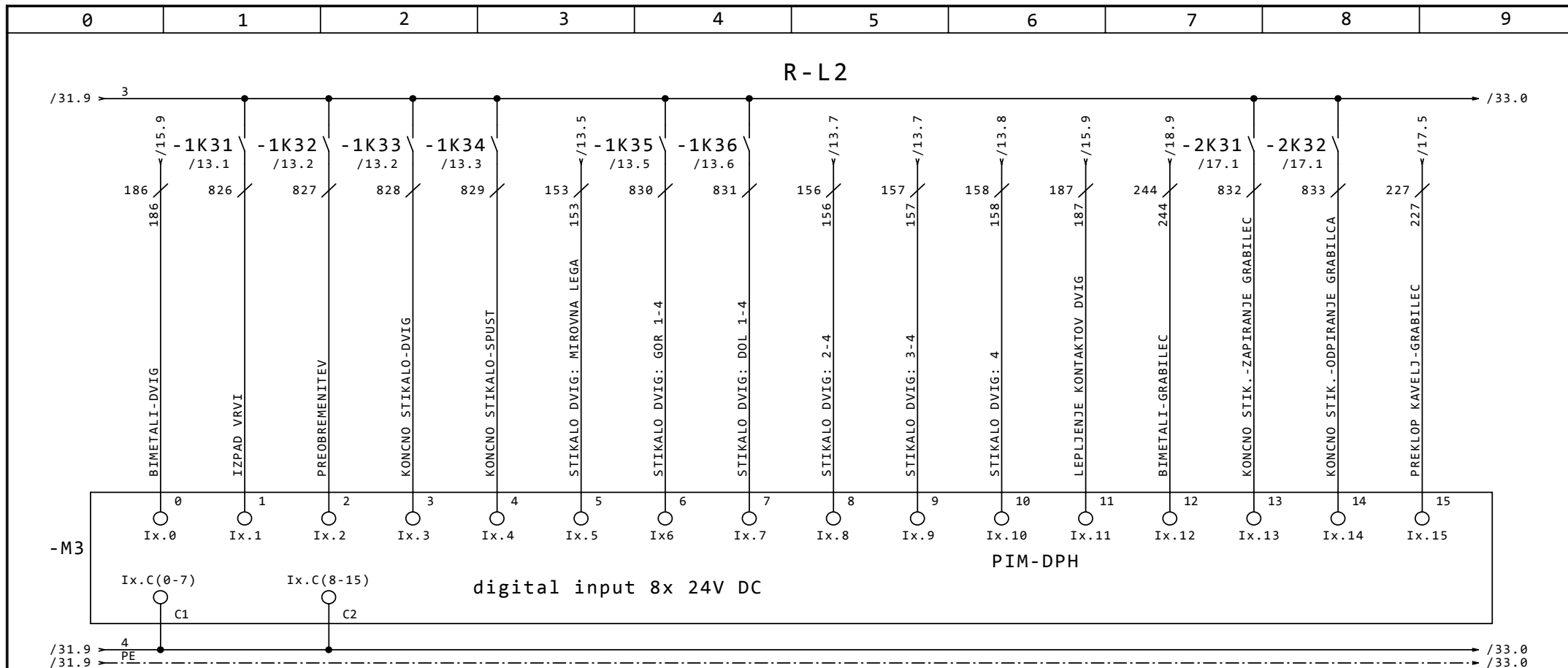

ROBOTINA d.o.o.  
Oprema in sistemi za  
avtomatizacijo  
TEL: 066 647 203  
FAX: 066 648 218

datum	22.12.99
projektiral	Ivan Morano
pregledal	
verzija	PZI 1.0

podpis	
--------	--

VRTLJIVI ZERJAV - OD 5 20/15/10 Mp x 25/30 m
objekt

LUKA KOPER
investitor

PLC KRMILNIK SKUPNI DEL V L2	PLC	=2 +L2
St. projekta 99060030	Skupina -2 -03 -8/4	stran 32 strani 37



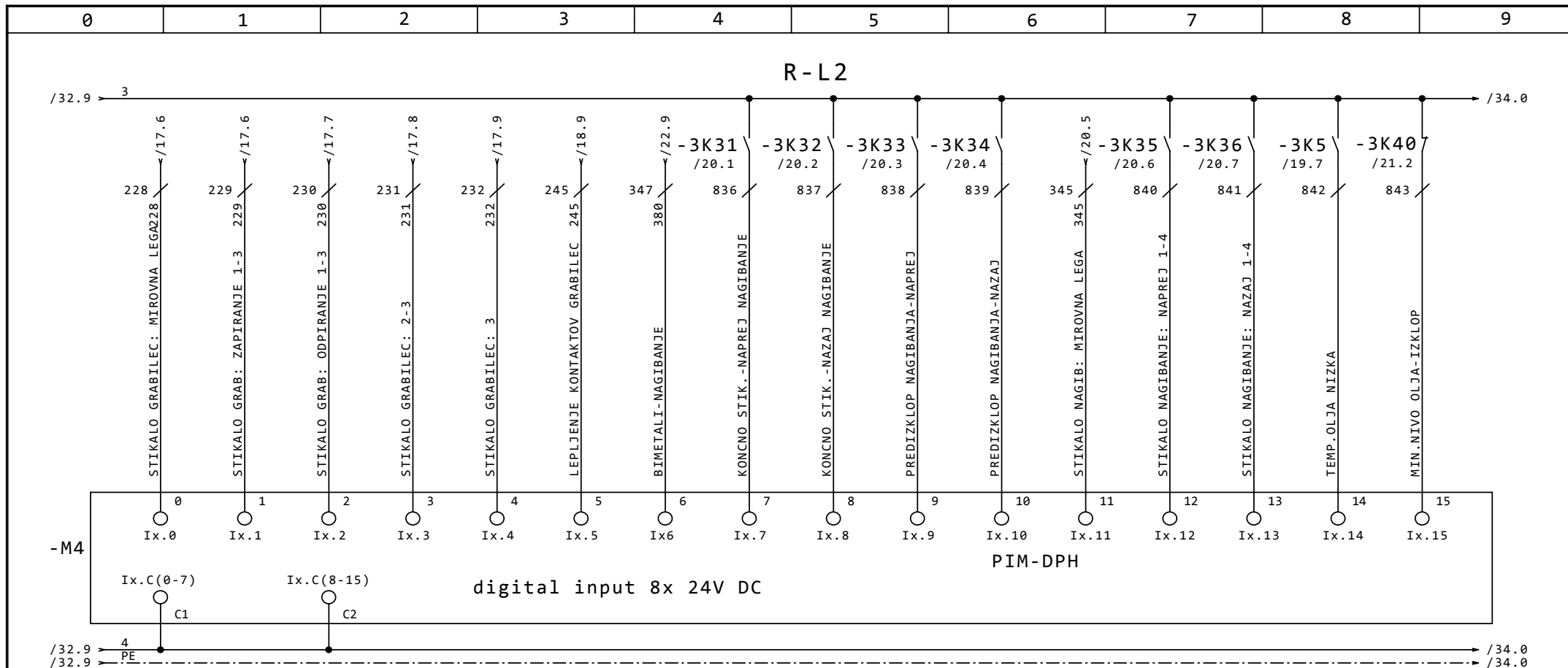

**ROBOTINA d.o.o.**  
 Oprema in sistemi za  
 avtomatizacijo  
 TEL: 066 647 203  
 FAX: 066 648 218

datum	22.12.99	podpis
projektiral	Ivan Morano	
pregledal		
verzija	PZI 1.0	

**VRTLJIVI ZERJAV - OD 5**  
**20/15/10 Mp x 25/30 m**  
 objekt

**LUKA**  
**KOPER**  
 investitor

PLC KRMILNIK  
 SKUPNI DEL V L2  
 St. projekta Skupina  
**99060030 -2 -03 -8/5**

<b>PLC</b>	=2
	+L2
	stran 33
	strani 37

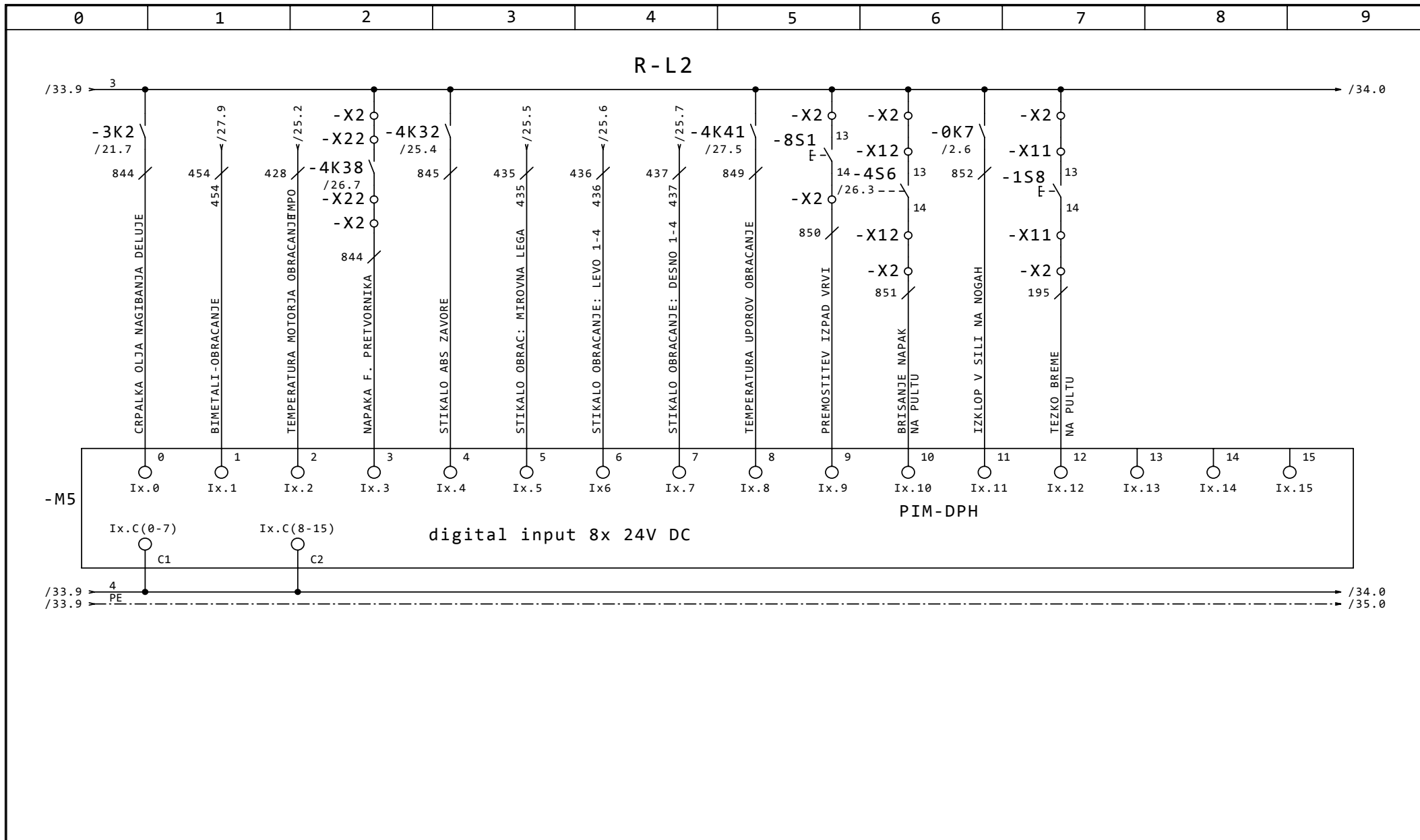

**ROBOTINA d.o.o.**  
 Oprema in sistemi za  
 avtomatizacijo  
 TEL: 066 647 203  
 FAX: 066 648 218

datum	22.12.99
projektiral	Ivan Morano
pregledal	
verzija	PZI 1.0

podpis	
--------	--

VRTLJIVI ZERJAV - OD 5 20/15/10 Mp x 25/30 m
objekt

LUKA KOPER
investitor

PLC KRMILNIK SKUPNI DEL V L2	Skupina
St. projekta	
99060030	-2 -03 -8/6

PLC	=2
	+L2
	stran 34
	strani 37

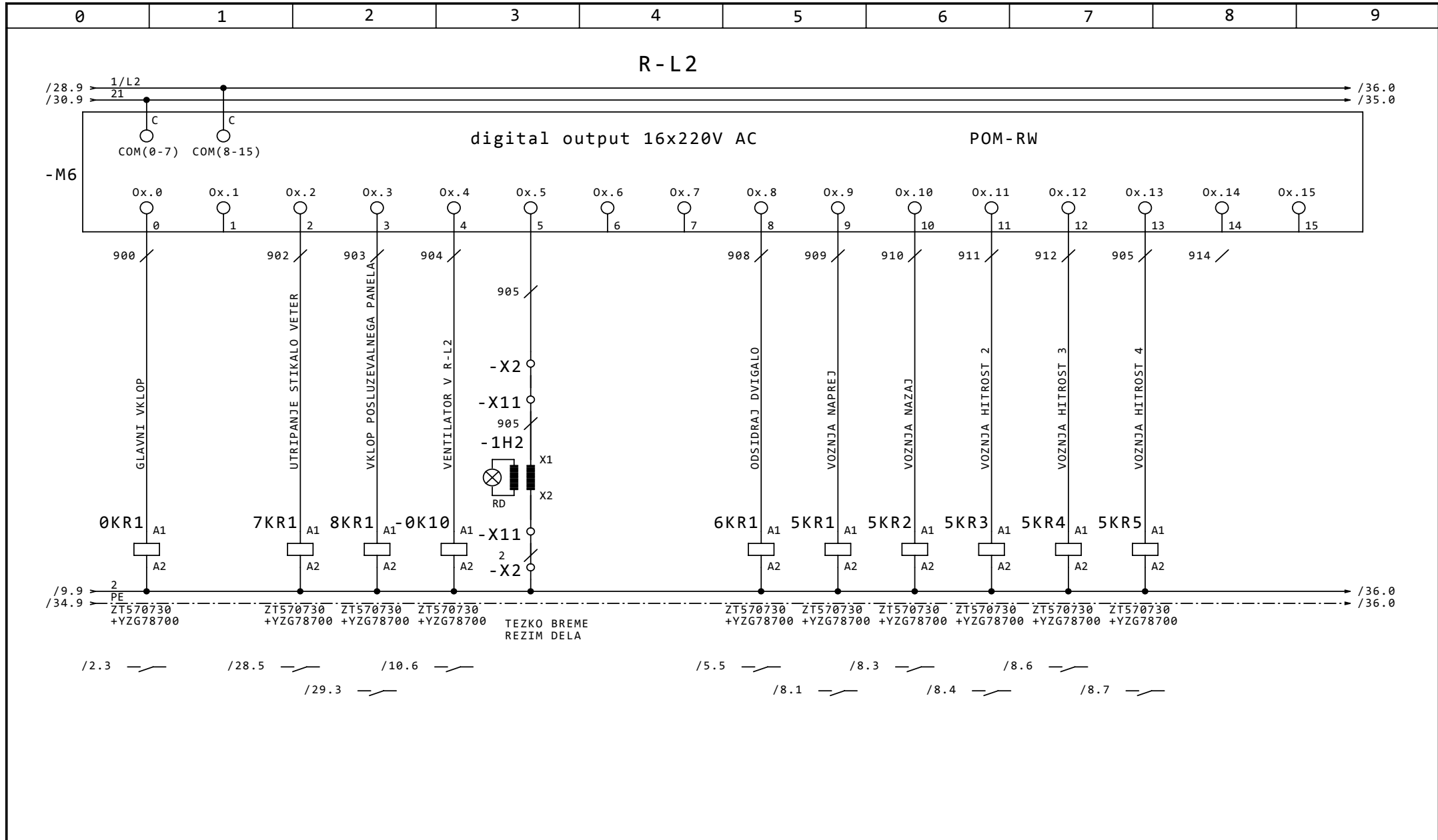

**ROBOTINA d.o.o.**  
 Oprema in sistemi za avtomatizacijo  
 TEL: 066 647 203  
 FAX: 066 648 218

datum	22.12.99	podpis	VRTLJIVI ZERJAV - OD 5	LUKA	PLC KRMILNIK	PLC	=2
projektiral	Ivan Morano		20/15/10 Mp x 25/30 m	KOPER	SKUPNI DEL V L2		+L2
pregledal			objekt	investitor	St. projekta	Skupina	stran 35
verzija	PZI 1.0				99060030		-2 -03 -8/7

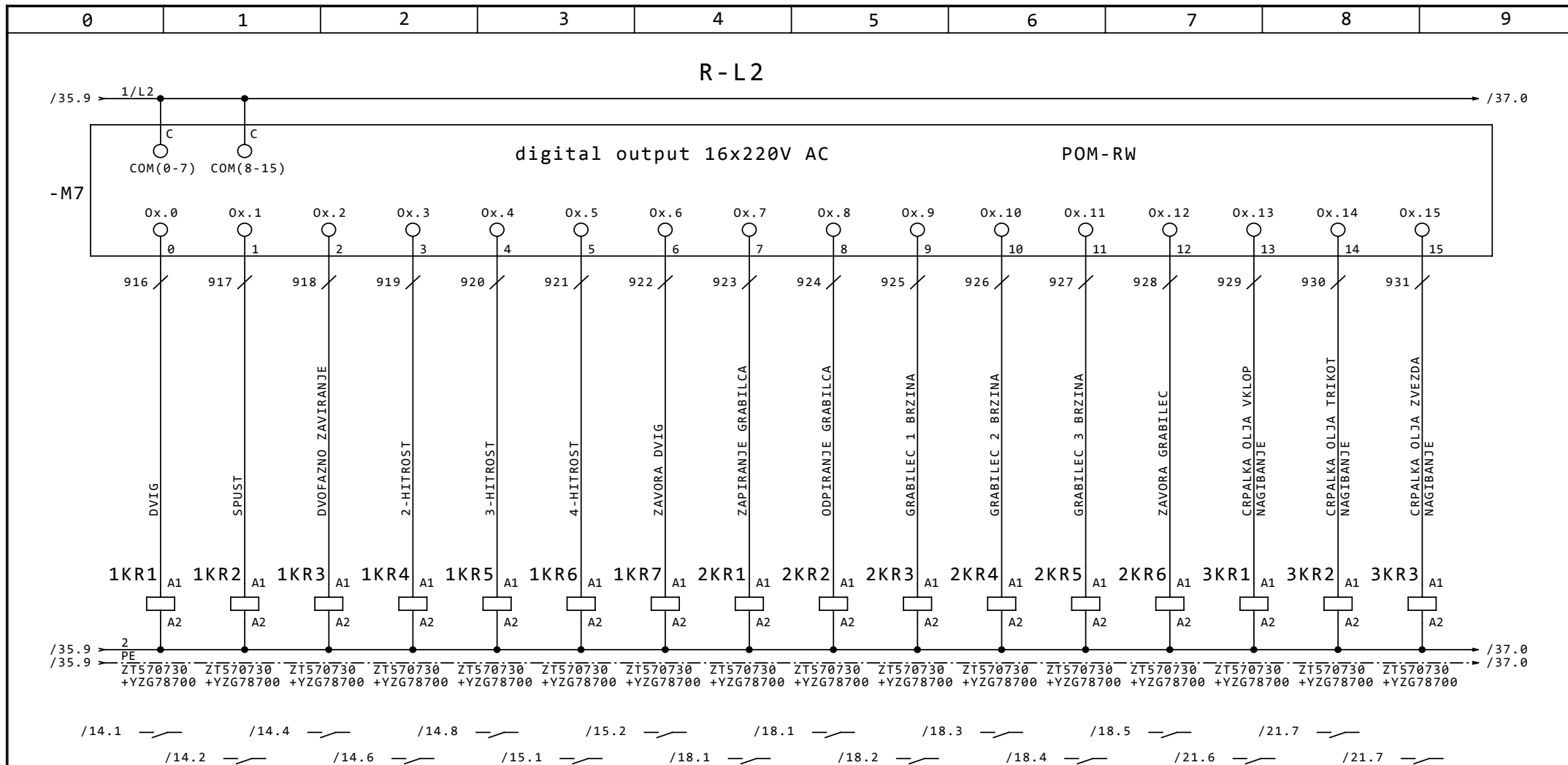

 <b>ROBOTINA d.o.o.</b> Oprema in sistemi za avtomatizacijo TEL: 066 647 203 FAX: 066 648 218	datum	22.12.99	podpis	<b>VRTLJIVI ZERJAV - OD 5</b> <b>20/15/10 Mp x 25/30 m</b> objekt	<b>LUKA</b> <b>KOPER</b> investitor	PLC KRMILNIK	<b>PLC</b> =2 +L2		
	projektiral	Ivan Morano				SKUPNI DEL V L2			
	pregledal					St. projekta		Skupina	stran 36
	verzija	PZI 1.0				99060030		-2 -03 -8/8	strani 37

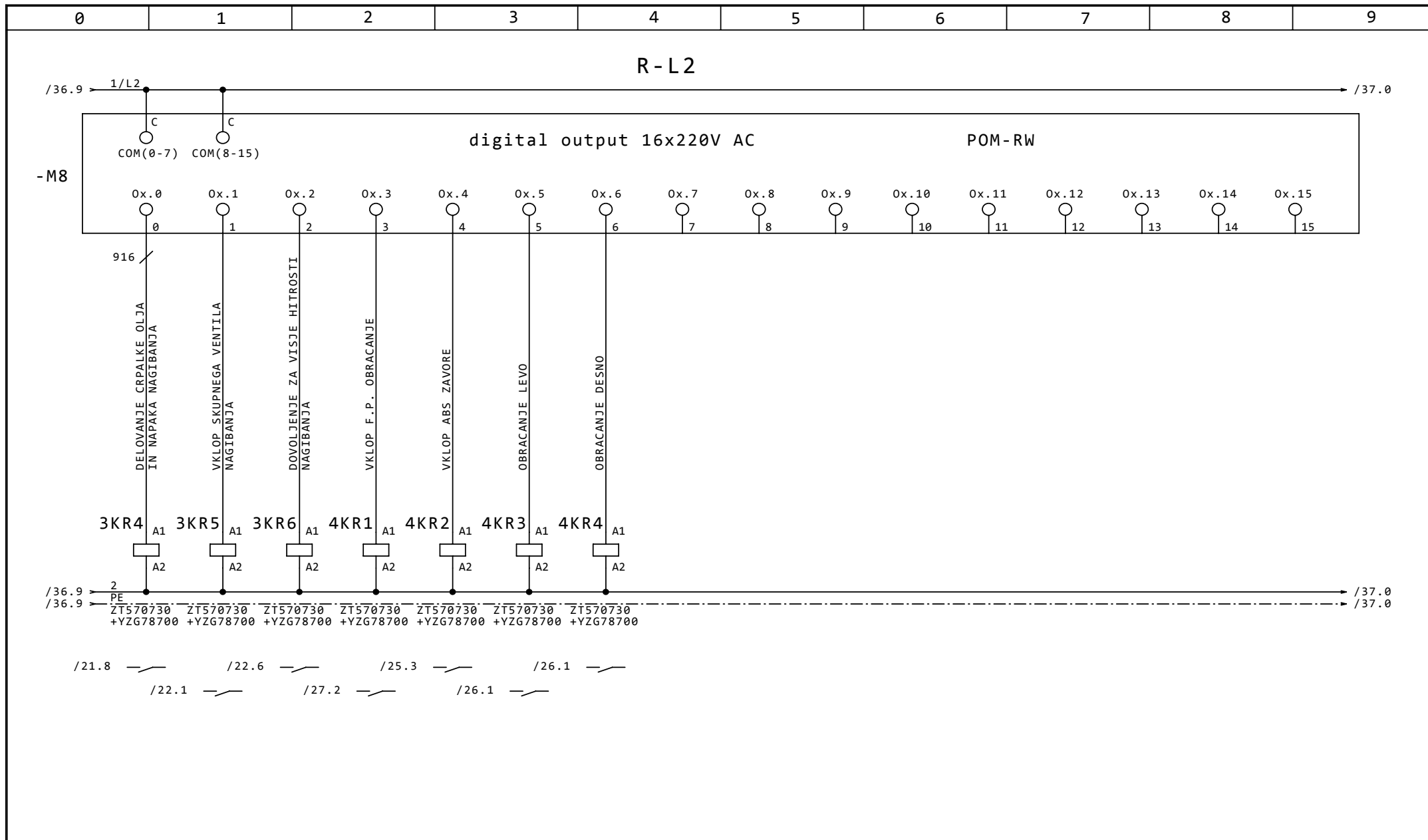

**ROBOTINA d.o.o.**  
 Oprema in sistemi za avtomatizacijo  
 TEL: 066 647 203  
 FAX: 066 648 218

datum	22.12.99
projektiral	Ivan Morano
pregledal	
verzija	PZI 1.0

podpis	
--------	--

VRTLJIVI ZERJAV - OD 5
20/15/10 Mp x 25/30 m
objekt

LUKA
KOPER
investitor

PLC KRMILNIK	Skupina
SKUPNI DEL V L2	
St. projekta	99060030
	-2 -03 -8/8

PLC	=2
	+L2
	stran 37
	strani 37